

WCC 310 & WCC 320 Plus versions

Installation instruction

MotorController

(Version 1811 – for firmware from version 1.33 (main card) &
from version 1.13 (motor line card))



Save this installation instruction to the end user

1	Safety information	4
1.1	Safety	4
1.2	230V AC	4
1.3	Application	4
1.4	Cable routing and electrical connection	4
2	Structure of the MotorController	5
3	Variants of MotorControllers	6
3.1	MotorController version	6
3.2	Max numbers of actuators per motor line and MotorController	7
4	Accessories and spare parts	8
5	Technical data	9
6	Mounting	10
7	Installation	10
7.1	Cable routing	10
7.2	Cables into housing	10
7.3	Connection of safety earth wire and 230V AC	10
7.4	Installation of the ventilation keypad	10
7.5	Assembly instructions	10
8	Cable dimensioning	11
8.1	Max. cable Length	11
8.1.1	Formula for the calculation of the maximum actuator cable length	11
8.1.2	Max cable length – ±24V standard actuators	11
8.1.3	Max cable length – actuators with MotorLink®	11
9	Cable plan for connection to WCC 310 / 320 Plus version	13
10	Description of cards and mains connection	14
10.1	WCC connection to mains and power supply units – WCA 3P3, WCA 3P4 and WCA 3P6	14
10.2	Connections between cards	14
10.3	Main control card WCA 3CP – Plus Version	15
10.4	Motor line card – WCA 3M4 / WCA 3M8	22
10.5	Keypad card – WCA 3KI	23
10.6	Power supply card – WCA 3P6	24
10.7	Fieldbus cards	24
11	Touch screen	25
11.1	Icons	25
11.2	Rotation of the touch screen	26
12	Configuration – main menu	26
12.1	Motor lines – motor groups	26
12.1.1	Examples with motor lines / motor groups	26
12.2	Motor line	27
12.2.1	Motor line - numbering	27
12.2.2	Motor line - configuration	27
12.2.3	Colour code - motor line	28
12.3	Motor group	28
12.3.1	Motor group - configuration	28
12.3.2	Colour code – motor group	28
12.4	Local input	29
12.4.1	Numbering of local inputs	29

12.4.2	Local input - configuration	29
12.4.3	Usage of wind/rain sensors - WLA 33x	30
12.5	Local output.....	30
12.5.1	Numbering of local output	30
12.5.2	Local output - configuration	31
12.6	Weather station type	31
12.7	Sequence control	32
12.8	WSK-Link™ - master/slave connection	33
12.9	Network	33
12.10	Log in	34
12.11	Configuration files on USB	35
12.12	System	36
12.13	Fieldbus (KNX and BACnet).....	36
12.13.1	KNX configuration	36
12.13.2	BACnet configuration	37
13	Status – main menu	37
14	Manual operation and main menu	38
15	Configuration missing – main menu	38
16	Hardware error – main menu.....	38
17	View all details – main menu.....	38
18	Remote control of MotorController	39
19	Commissioning and test run.....	39
19.1	The MotorController is completely installed, without the operating voltage applied	39
19.2	With mains voltage	40
19.3	Ventilation keypad.....	40
19.4	Wind/rain detector	40
20	Maintenance	40
20.1	Maintenance agreements.....	40
20.2	Replacement cards	40
20.2.1	Replacement of 3M4, 3M8 and 3KI cards	40
20.2.2	Replacement of 3CP card	40
21	Declaration of Conformity	40

1 Safety information

1.1 Safety

Only allow correspondingly trained, qualified and skilled personnel to carry out installation work.

Reliable operation and the avoidance of damage and hazards are only guaranteed if installation and settings are carried out carefully in accordance with these instructions.

There may be personal danger by electrically operated windows:

- the forces occurring in the automatic mode can be such that parts of the body could get crushed
- when opened, actuators (spindles) could protrude into the room

For this reason, measures have to be taken prior to starting up the actuators, which exclude the danger of injury.

For safety reasons we recommend to install opening restrictors on bottom-hung windows.

In the event that windows are subjected to rain and/or high wind loads, we recommend connecting a wind/rain sensor to the MotorController for the automatically closing of the windows.

The MotorController is to be located in a safe place, protected from the effects of fire and smoke.

The MotorController is to be surface mounted.

The MotorController is supplied by 230V AC

The manufacturer does not assume any liability for possible damage resulting from inappropriate use.

1.2 230V AC

230V AC can cause death, severe injury or considerable damage to assets.

The connection of the MotorController is reserved for qualified personnel.

Disconnect all poles of the MotorController from the supply voltage prior to opening, installation or assembling.

Installation and use according to the national regulations.

1.3 Application

The MotorController is exclusively designed for the automatic opening and closing of windows, flaps or doors.

Always check that your system meets the valid national regulations.

Pay particular attention to the opening cross section, the opening time and opening speed.

The cable cross sections depend on the cable length and current consumption (amperage).

1.4 Cable routing and electrical connection

Fuse the 230VAC power supply cable separately on site.

Cable routing and connection - adhere to national regulations.

Establish the cable types, if necessary, with the local approval bodies.

Do not conceal flexible cables.

Junction box must be accessible for maintenance purposes.

Disconnect all poles of the mains voltage prior to starting maintenance work or making changes to the system.

Secure the system to prevent unintentional switching on again.

Route all low voltage cables (24VDC) separate from the power current cables.

Design cable types, lengths and cross sections in accordance with the technical information.

Cable specifications is a guide only, the overall responsibility resides with the electrical contractor on site.

Installation must be in accordance with the national electrical regulations.

2 Structure of the MotorController

Sizes & Versions

The WCC 310 and WCC 320 MotorControllers are available in two different versions namely a Standard and a Plus version. This installation instruction only deals with the Plus versions. Please see separate installation instruction for the Standard versions of WCC 310 and WCC 320.

Cards

Each MotorController contains a power supply unit (SMPS), either a WCA 3P3 or a WCA 3P4 for the 10A or 20A version respectively, as well as a 5W auxiliary power supply. Aside from the power supply unit the Plus version also includes a main control card type WCA 3CP, which includes a touch screen for easy configuration of the MotorController. Motor line and input cards, as well as fieldbus cards, can be added to the MotorController depending on requirements.

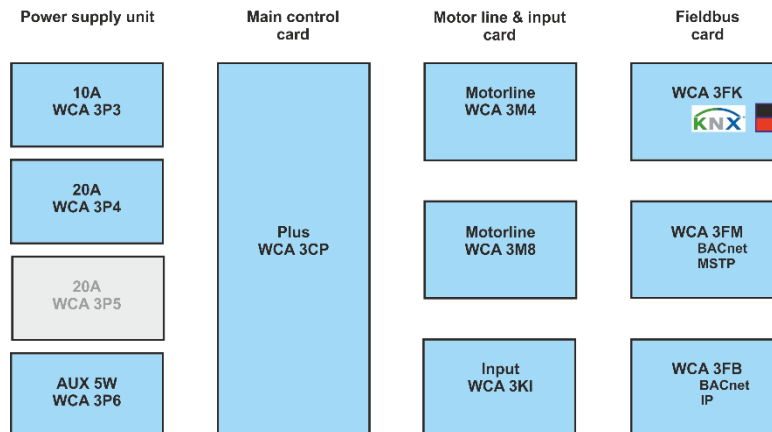

Selection of cards

The Main control card type WCA 3CP allows connections of 2 motor lines and 2 keypads. If more than 2 motor lines or 2 keypads are required, the necessary cards can be added.

Cards:

- WCA 3M4 motor line card, allows additional 4 motor lines.
- WCA 3M8 motor line card, allows additional 8 motor lines.
- WCA 3KI input card, allows additional 10 keypads (requires WCA 3M4 or WCA 3M8).

A fieldbus card must be added, if communication via KNX or BACnet is required.

Fieldbus cards:

- WCA 3FK fieldbus card, fieldbus interface for KNX
- WCA 3FM fieldbus card, fieldbus interface for BACnet / MSTP
- WCA 3FB fieldbus card, fieldbus interface for BACnet IP

Installation of cards may only be done when there is no power on the MotorController. Motor line and input cards are ordered together with the MotorController and mounted to the MotorController from the factory side, whereas the fieldbus cards are delivered as individual products and are to be mounted by the customer – see separate installation manual for mounting of fieldbus card.

The item no. of the MotorController specifies the type and mounting of the cards - see "Variants of MotorController" for more information

Motor groups and motor lines

A motor group consists of one or more motor lines and all the motor lines are operated simultaneously.

The motor lines on both the main control card (WCA 3CP) and the motor line cards (WCA 3M4 or WCA 3M8) can all be configured for either a $\pm 24V$ standard actuators or MotorLink[®] actuators. A motor group can contain motor lines with both $\pm 24V$ standard actuators and MotorLink[®] actuators, whereas a motorline only can have $\pm 24V$ standard or MotorLink[®] actuators connected.

Adding MotorControllers

The natural ventilation installation can be expanded by adding more MotorControllers and creating a master/slave connection among them. The master/slave connection is done directly on the WSA 3CP card. The total cable length between 2 MotorControllers must not exceed 200m.

3 Variants of MotorControllers

Item composing						
WCC 3	xx	x	xx	xx	0x	
					0x = Product version number For NV Embedded® the MotorControlleren must minimum ve version 02	
					<u>Input card*</u> 02 = No input card 12 = Input card (10 additional keypad inputs)	
					<u>Motor line card</u> 02 = No motor line card 06 = Motor line card (4 additional lines) 10 = Motor line card (8 additional lines)	
					<u>MotorController version</u> S = Standard P = Plus	
					<u>MotorController size</u> 10 = 10A 20 = 20A	
MotorController series 3						

*requires a motor line card

3.1 MotorController version

Number of motor lines and other functions	Cards	Item number
WCC 310 versions		
Plus version 2 motor lines 2 keypads / inputs	1 x WCA 3CP	WCC 310 P 0202 03
Plus version 6 motor lines 12 keypads / inputs	1 x WCA 3CP 1 x WCA 3M4 1 x WCA 3KI	WCC 310 P 0612 03
Plus version 10 motor lines 12 keypads / inputs	1 x WCA 3CP 1 x WCA 3M8 1 x WCA 3KI	WCC 310 P 1012 032
WCC 320 versions		
Plus version 2 motor lines 2 keypads / inputs	1 x WCA 3CP	WCC 320 P0202 03
Plus version 6 motor lines 12 keypads / inputs	1 x WCA 3CP 1 x WCA 3M4 1 x WCA 3KI	WCC 320 P 0612 03
Plus version 10 motor lines 12 keypads / inputs	1 x WCA 3CP 1 x WCA 3M8 1 x WCA 3KI	WCC 320 P 1012 03

3.2 Max numbers of actuators per motor line and MotorController

The table shows the maximum number of actuators, which can be connected per motor line and MotorController depending on the type of the actuator, MotorController and connected card. The total power consumption of all the connected actuators must not exceed 10A for WCC 310 and 20A for WCC 320.

	Per motor linie		Per 10A MotorController		Per 20A MotorController	
	± 24V actuators	MotorLink® actuators	± 24V actuators	MotorLink® actuators (10 Motor lines)	± 24V actuators	MotorLink® actuators (10 Motor lines)
WMD 820-1	10	4	10	10	20	20
WMD 820-2	10	2	10	10	20	20
WMD 820-3	9	3	9	9	18	18
WMD 820-4	8	4	8	8	20	20
WMS 306-1	10	4	10	10	20	20
WMS 306-2	10	2	10	10	20	20
WMS 306-3	9	3	9	9	18	18
WMS 306-4	8	4	8	8	20	20
WMS 309-1	10	4	10	10	20	20
WMS 309-2	10	2	10	10	20	20
WMS 309-3	9	3	9	9	18	18
WMS 309-4	8	4	8	8	20	20
WMS 409 xxxx 01	5	0	5	0	10	0
WMS 409-1	5	4	5	5	10	10
WMS 409-2	4	2	4	4	10	10
WMS 409-3	3	3	3	3	9	9
WMS 409-4	4	4	4	4	8	8
WMU 831 / 836 / 851-1	10	4	10	10	20	20
WMU 831 / 836 / 851-2	10	2	10	10	20	20
WMU 831 / 836 / 851-3	9	3	9	9	18	18
WMU 831 / 836 / 851-4	8	4	8	8	20	20
WMU 861-1	6	4	6	6	12	12
WMU 861-2	6	2	6	6	12	12
WMU 861-3	6	3	6	6	12	12
WMU 861-4	4	4	4	4	12	12
WMU 842 / 852 / 862 / 882-1	4	4	4	4	8	8
WMU 842 / 852 / 862 / 882-2	4	2	4	4	8	8
WMU 842 / 852 / 862 / 882-3	3	3	3	3	6	6
WMU 842 / 852 / 862 / 882-4	4	4	4	4	8	8
WMU 863 / 883-1	3	3	3	3	6	6
WMU 863 / 883-2	2	2	2	2	6	4
WMU 863 / 883-3	3	3	3	3	6	6
WMU 863 / 883-4	0	0	0	0	4*	4*
WMU 864 / 884-1	2	2	2	2	4	4
WMU 864 / 884-2	2	2	2	2	4	4
WMU 864 / 884-3	0	0	0	0	3*	3*
WMU 864 / 884-4	0	0	0	0	4*	4*
WMU 885 / 895-1	2	2	2	2	4	4
WMU 885 / 895-2	2	2	2	2	4	4
WMU 885 / 895-3	0	0	0	0	3*	3*
WMU 885 / 895-4	0	0	0	0	4*	4*
WMX 503 / 504 / 523 / 526-1	20	4	20	20	40	40
WMX 503 / 504 / 523 / 526-2	20	2	20	16	40	20
WMX 503 / 504 / 523 / 526-3	18	3	18	18	39	30
WMX 503 / 504 / 523 / 526-4	20	4	20	20	40	40

	Per motor linie		Per 10A MotorController		Per 20A MotorController	
	± 24V actuators	MotorLink® actuators	± 24V actuators	MotorLink® actuators (10 Motor lines)	± 24V actuators	MotorLink® actuators (10 Motor lines)
WMX 803 / 804 / 813 / 814 / 823 / 826-1	10	4	10	10	20	20
WMX 803 / 804 / 813 / 814 / 823 / 826-2	10	2	10	10	20	20
WMX 803 / 804 / 813 / 814 / 823 / 826-3	9	3	9	9	18	18
WMX 803 / 804 / 813 / 814 / 823 / 826-4	8	4	8	8	20	20
WML 820/825	10	0	10	0	20	0
WML 860-1	10	4	10	10	20	20
WML 860-2	10	2	10	10	20	20
WML 860-3	9	3	9	9	18	18
WML 860-4	8	4	8	8	20	20
WMB 801/802**	max. 4A tilsluttet på WMB					
WMB 811/812 **/**	10	2	10	10	20	20

* When the motor line is configured to 20A output

** Do not exceed the total power consumption of the motor line

*** When having two locking actuators per motor line, it must be one of each type: 1 x WMB 811 and 1 x WMB 812

4 Accessories and spare parts

Accessories	
Fieldbus card with field bus interface for KNX incl. cover – sold separately, not factory mounted	WCA 3FK
Fieldbus card with field bus interface for BACnet / MSTP incl. cover - sold separately, not factory mounted	WCA 3FM
Fieldbus card with field bus interface for BACnet-IP incl. cover - sold separately, not factory mounted	WCA 3FB
Rain sensor	WLA 331
Rain/wind speed sensor	WLA 330
Rain/wind speed sensor, with pulse output	WLA 340
Wind speed sensor & Wind direction sensor	WOW 201 & WOW 202
Bracket for junction box	WOW 203
Junction box for WOW 201 and WOW 202	WOW 204
Cable for wind and rain sensor WLA 340, 4m UV-resistant cable 4 x 2 x 0,75mm ²	WLL 604
Spare parts	
10A power supply unit for WCC 310	WCA 3P3
20A power supply unit for WCC 320	WCA 3P4
5W 230 AC / 24V DC	WCA 3P6
Main control card for Plus version WCC 310 / WCC 320 incl. cover	WCA 3CP
Motor line card with 4 motor lines incl. cover	WCA 3M4
Motor line card with 8 motor lines incl. cover	WCA 3M8
Input card with 10 inputs for e.g. key pads incl. cover (requires WCA 3M4 or WCA 3M8)	WCA 3KI
Plastic covers for the cards in the WCC 310 / WCC 320 Plus version	WCA 301
Fieldbus card with field bus interface for KNX incl. cover	WCA 3FK
Fieldbus card with field bus interface for BACnet / MSTP incl. cover	WCA 3FM

5 Technical data

Technical data	
Output current (nominal)	WCC 310: 10A / WCC 320: 20A
Secondary voltage	Voltage 24V DC ($\pm 15\%$) Open circuit voltage (no load) 27,6V DC @ 20°C Ripple at max load max. 6% (3,5Vpp)
AUX	24V DC, 0.23A
Motor lines	WCC 310 0202: max 2, WCC 320 1012: max 10 A motor line can contain either $\pm 24V$ standard or MotorLink [®] actuators
Motor groups	WCC 310 0202: max 2, WCC 320 1012: max 10 Via the touch screen motor motorlines can be connected in the same group
Primary voltage	230V AC, 50Hz (85-264V AC, 47-63Hz)
Power consumption	Idle consumption WCC 310: min 2W ¹ , typ. 4.2W ² WCC 320: min 2W ¹ , typ. 5W ³ 1) min.: 1 MotorLink [®] actuator 2) min.: 20 MotorLink [®] actuators + rain sensor 3) min.: 40 MotorLink [®] actuators + rain sensor Max: WCC 310: At max load 305W WCC 320: At max load 605W
Inrush current on primary site	70A<5ms. Max 3 x WCC 310/320 per 10 A supply group. Circuit breaker "C" characteristic.
$\pm 24V$ change over time	min 500ms
Cable monitoring	$\pm 24V$ standard actuators with end of line module are monitored by closed-circuit Actuators with MotorLink [®] are monitored by data communication
LED message OK and fault	Green CPU working Yellow fault
Connection cable	Actuators flexible max 6 mm ² / solide max 10 mm ² Other components min 0,2mm ² / max 1,5mm ²
Operating conditions	-5°C - +40°C, for indoor only, MotorController must not be covered
Max actuator activation duration (duty cycle)	ED 40% (4min. per 10min.)
Number of motor lines per card	WCA 3CP 2 x 10A motor line for $\pm 24V$ standard or MotorLink [®] actuators WCA 3M4 4 x 10A motor line for $\pm 24V$ standard or MotorLink [®] actuators WCA 3M8 8 x 10A motor line for $\pm 24V$ standard or MotorLink [®] actuators
Material	Metal housing for surface mounting
Colour	White (RAL 9010)
Size	355 x 320 x 76mm (HxWxD)
Weight	WCC 310: 4kg WCC 320: 4.8kg
Protection class	IP 20
Delivery	MotorController
Note	We reserve the right to make technical changes

6 Mounting

The MotorController is fixed to the wall through the Ø6mm holes in the back plane of the housing.

The MotorController is to be located in a safe place, protected from the effects of fire and smoke.

With reference to the machinery directive EN 60204-1, the MotorController has to be placed where it is only accessible to authorized persons and mounted where there is no particular regard for dust and moisture.

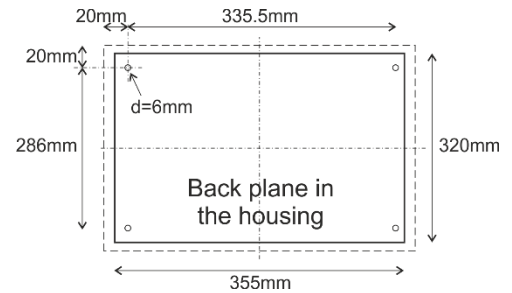

7 Installation

7.1 Cable routing

See also chapter 8 "Cable dimensioning" in this instruction.

However, this has to be agreed with the Engineer.

Do not reduce the cable cross sections specified in the cable lengths table.

All cables of the control (except the mains supply cable) carry 24V DC and have to be routed separate from the mains supply cable.

Adhere to the pertinent national and local regulations when routing the cables.

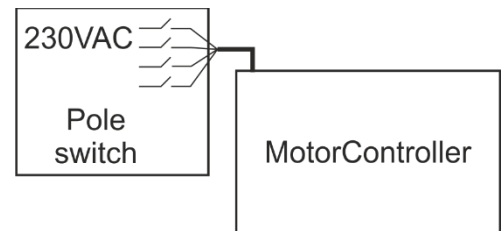

7.2 Cables into housing

All connection terminals (except the mains terminals) are of the plug-in type.

Connect the connection cables in accordance with the terminal plan. Ensure that the connections are made correctly.

Incorrect cable clamping, mixing up numbers or colours could lead to malfunctions of the control MotorController or of the external components.

Ensure that the electrical cables are always routed according to the valid national and local regulations.

7.3 Connection of safety earth wire and 230V AC

See chapter 10 'Description of cards', for further description.

7.4 Installation of the ventilation keypad

Ensure that the ventilation buttons are visible and well accessible. Do not install behind protruding walls, door MotorControllers or hidden by the building structure.

7.5 Assembly instructions

Always have assembly, installation, repair and maintenance of ventilation systems carried out by qualified personnel trained for this purpose.

Rules to be adhered to for setting up and installation

The following safety relevant rules have to be adhered to when planning the use of a ventilation system and its set-up and installation:

- The Provincial Building Ordinance of the provinces

Accident prevention regulations

Adhere to the general accident prevention regulations (APR), the APR for power operated windows and doors, and the installation rules in your country.

CAUTION:

Live components are directly accessible after opening the system housing.

Prior to inserting / removing cards disconnect to the MotorController from the mains supply.

- adhere to the installation instructions and your local energy providers
- select the place of installation such that free access is guaranteed for maintenance purposes
- select cables according to regulations in this instruction - take the calculation of the actuators supply cable lengths into account when laying the cables
- connect the cables in accordance with the drawings provided by the manufacturer
- route the cables in the building according to the regulations in this instruction
- check all system functions

8 Cable dimensioning

8.1 Max. cable Length

Maximum permissible cable length from the MotorController to the actuators taking into account the cable cross-section is shown in the following tables for “± 24V standard actuators“, “MotorLink® actuators“.

8.1.1 Formula for the calculation of the maximum actuator cable length

$$\text{Max. cable length} = \frac{\text{permissible voltage drop } 2\text{V (UL)} \times \text{conductivity of copper(56)} \times \text{cable cross section in mm}^2 \text{ (a)}}{\text{max. actuator current total in amps (I)} \times 2}$$

For both ±24V standard actuators and actuators with MotorLink® the cross section of the cable must not be less than 0.75mm² regardless of the result of above formula.

Maximum actuator cable length: Always measured from the Motorcontroller to the last junction box + actuator cable

Permissible max. voltage drop in the line: 2 Volt

Actuating current: Sum of all actuator power consumption per motor line

Note: do not use the PE wire / green/yellow wire in the actuator cable!

Example

Max actuator cable length with cable cross section 0.75mm² and actuator current 2A: $(2 \times 56 \times 0.75) : (2 \times 2) = 21\text{m}$

8.1.2 Max cable length – ±24V standard actuators

The actuator supply cable must have 2 wires. If monitoring is desired use min. 3: 2 wires current carrying / 1 wire for monitoring.

±24V standard actuators						
Do not use the PE wire / green/yellow wire!						
cable cross section [a]	3 wire 0,75mm ²	3 wire 1,50 mm ²	5 wire 1,50 mm ² 2 wire parallel	3 wire 2,50 mm ²	5 wire 2,50 mm ² 2 wire parallel	3 wire 4,00 mm ²
Total actuator current [I]						
1A	42m	84m	168m	140m	280m	224m
2A	21m	42m	84m	70m	140m	112m
3A	14m	28m	56m	47m	93m	75m
4A	11m	21m	42m	35m	70m	56m
5A	8m	17m	34m	28m	56m	45m
6A	7m	14m	28m	23m	47m	37m
7A	6m	12m	24m	20m	40m	32m
8A	5m	11m	21m	18m	35m	28m
9A		9m	18m	15m	31m	25m
10A		8m	16m	14m	28m	22m
20A		4m	8m	7m	14m	11m

8.1.3 Max cable length – actuators with MotorLink®

The actuator supply cable must have 3 wires: 2 wires current carrying / 1 wire for communication.

When a 5 wire cable is used for MotorLink®

It is not recommended to use parallel-wire.

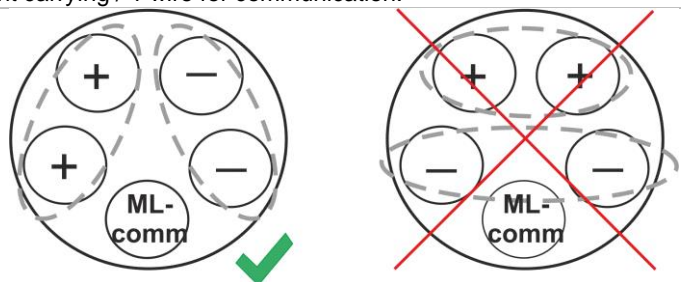

ML-comm = MotorLink® communication.

When using actuators with MotorLink® the max cable length is 50m regardless of the result of the above mentioned formula.

Actuators with MotorLink®						
Do not use the PE wire / green/yellow wire!						
cable cross section [a]	3 wire 0.75mm²	3 wire 1.50 mm²	5 wire 1.50 mm² 2 wire parallel	3 wire 2.50 mm²	5 wire 2.50 mm² 2 wire parallel	3 wire 4.00 mm²
Total actuator current [I]						
1A	42m	50m				
2A	21m	40m	50m			
3A	14m	28m	50m	47m	50m	
4A	11m	21m	42m	35m	50m	
5A	8m	17m	34m	28m	50m	45m
6A	7m	14m	28m	23m	47m	37m
7A	6m	12m	24m	20m	40m	32m
8A	5m	11m	21m	18m	35m	28m
9A		9m	18m	15m	31m	25m
10A		8m	16m	14m	28m	22m
20A		4m	8m	7m	14m	11m

9 Cable plan for connection to WCC 310 / 320 Plus version

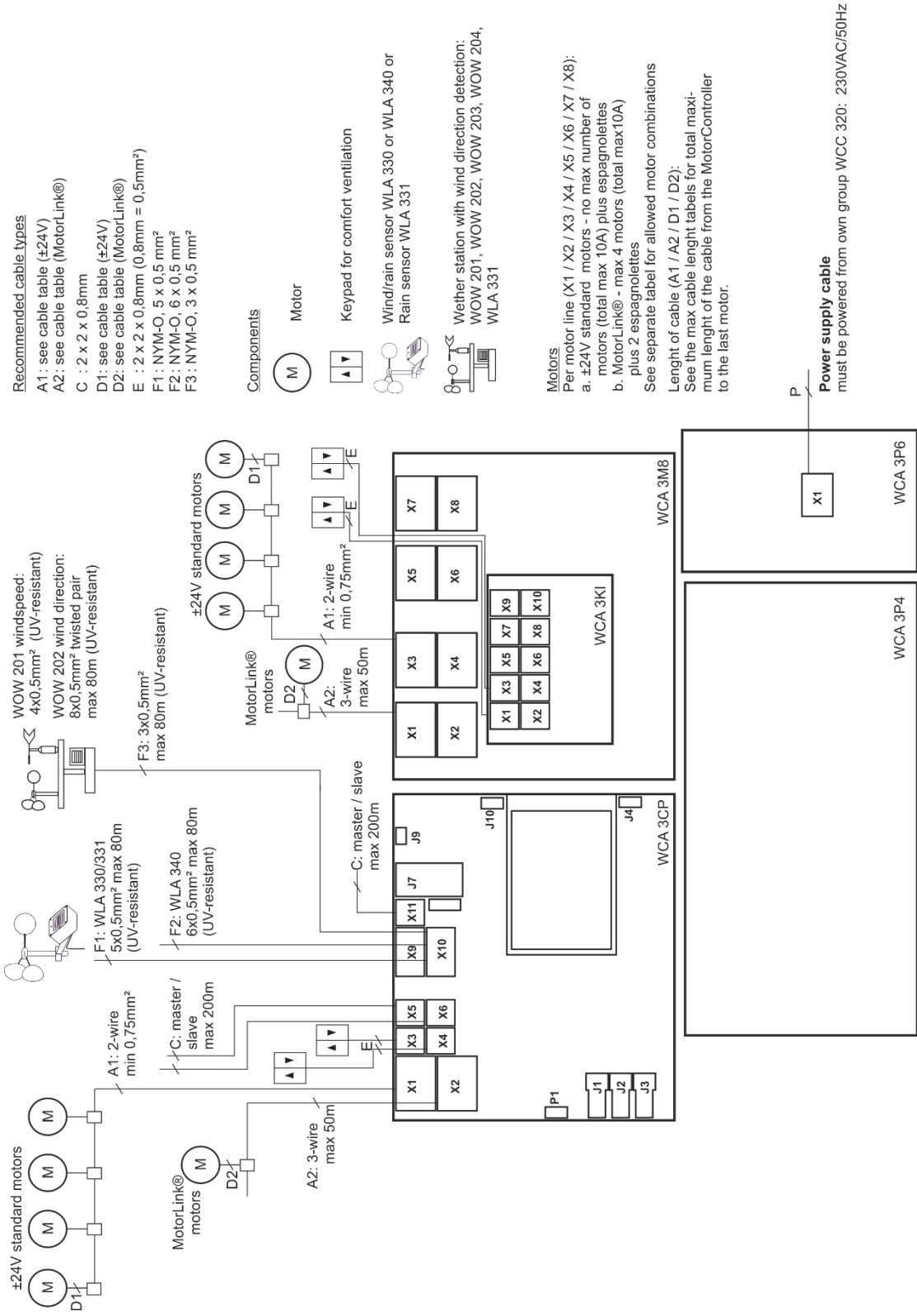

Recommended cable types

- A1: see cable table (±24V)
- A2: see cable table (MotorLink®)
- C : 2 x 2 x 0,8mm
- D1: see cable table (±24V)
- D2: see cable table (MotorLink®)
- E : 2 x 2 x 0,8mm (0,8mm = 0,5mm²)
- F1: NYM-O, 5 x 0,5 mm²
- F2: NYM-O, 6 x 0,5 mm²
- F3: NYM-O, 3 x 0,5 mm²

Components

- Motor
- Keypad for comfort ventilation
- Wind/rain sensor WLA 330 or WLA 340 or Rain sensor WLA 331
- Wether station with wind direction detection: WOW 201, WOW 202, WOW 203, WOW 204, WLA 331

Motors

- Per motor line (X1 / X2 / X3 / X4 / X5 / X6 / X7 / X8):
- a. ±24V standard motors - no max number of motors (total max 10A) plus espagnoilettes
- b. MotorLink® - max 4 motors (total max 10A) plus 2 espagnoilettes

See separate label for allowed motor combinations
 Length of cable (A1 / A2 / D1 / D2):
 See the max cable length labels for total maximum length of the cable from the MotorController to the last motor.

Power supply cable

must be powered from own group WCC 320: 230VAC/50Hz

The above plan shows a WCC 320 MotorController

10 Description of cards and mains connection

Each MotorController includes a power supply unit (SMPS), an auxiliary power supply (AUX) and a main control card. Motor line can input cards for additional motor lines and inputs (e.g. for key pads) as well as a field bus card can be added when necessary.

The size of the power supply unit determines the number and/or types of actuators, which can be connected to the MotorController. See table with overview of max number of allowed actuators per motor line/MotorController (chapter 0).

10.1 WCC connection to mains and power supply units – WCA 3P3, WCA 3P4 and WCA 3P6

The MotorController WCC 310 is supplied with a 305W SMPS power supply – WCA 3P3.

The MotorController WCC 320 is supplied with a 605W SMPS power supply – WCA 3P4.

The power supply is, regardless of size, placed in the bottom of the MotorController beneath the motor line and input card. An AUX – WCA 3P6 – to which mains is connected, is located to the right of the power supply.

Outlet to mains is in the top right of the MotorController.

The MotorController is grounded by means of protective earth via the green screw next to WCA 3P6.

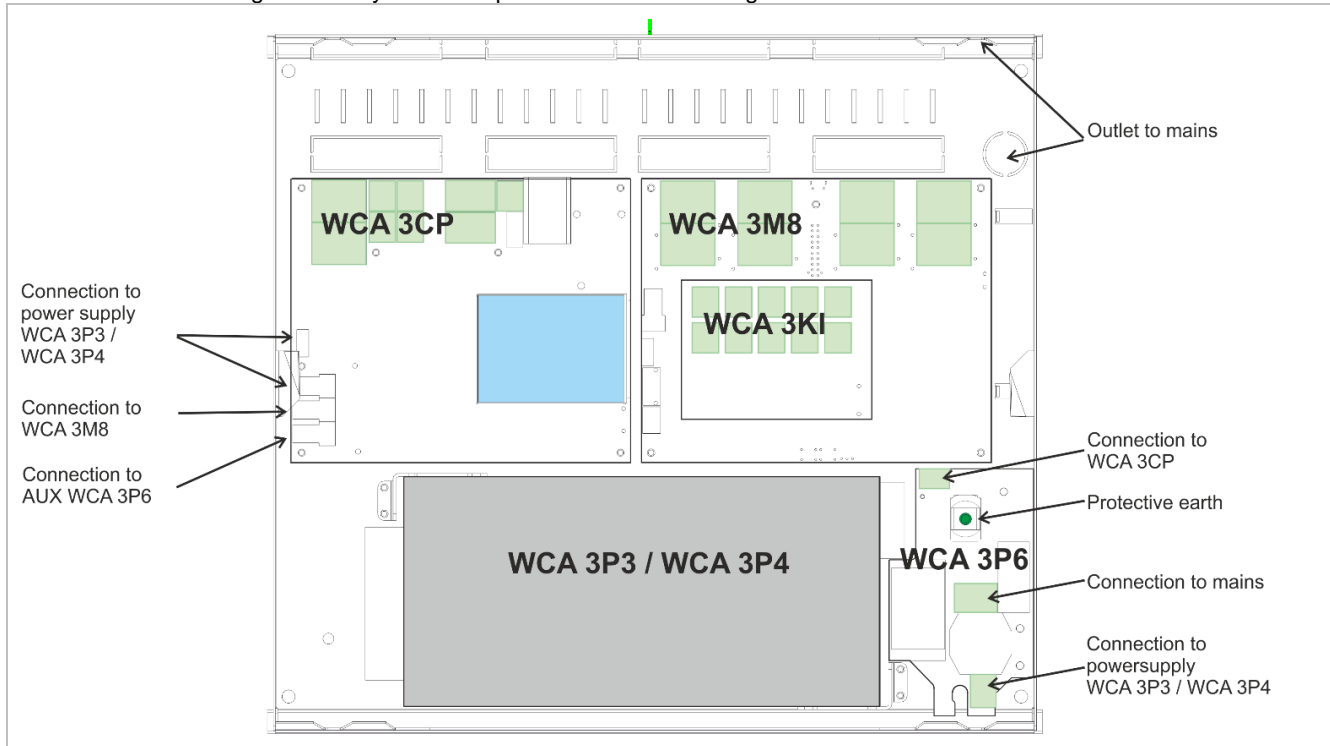

10.2 Connections between cards

An overview of how the different cards are connected are shown below.

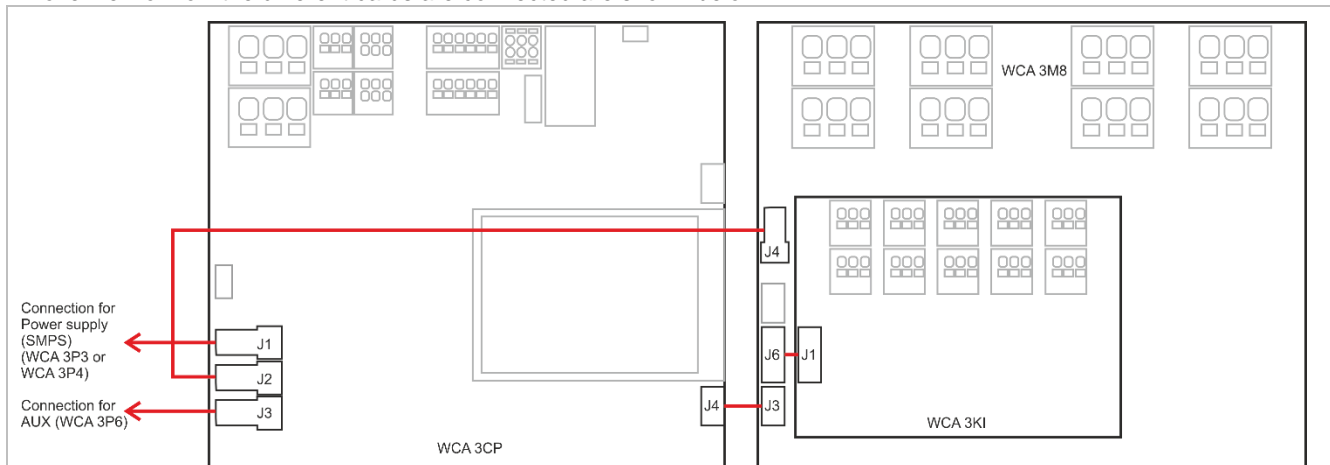

10.3 Main control card WCA 3CP – Plus Version

Each WCA 3CP contains the following:

- 2 motor lines for ±24V standard or Motorlink® actuators
- 2 input for keypads for comfort ventilation
- Input for weather station incl. wind direction (WLA 330 / 331 / 340 / WOW 201 / 202)
- Input for master / slave connection (WSK-Link™)
- connection of power supply
- connection to AUX
- Power for motor line card
- Connection for motor line card
- Two connections for Ethernet
- Connection for USB host and USB device
- Connection for fieldbus card
- Touch screen for configuration, commissioning and maintenance

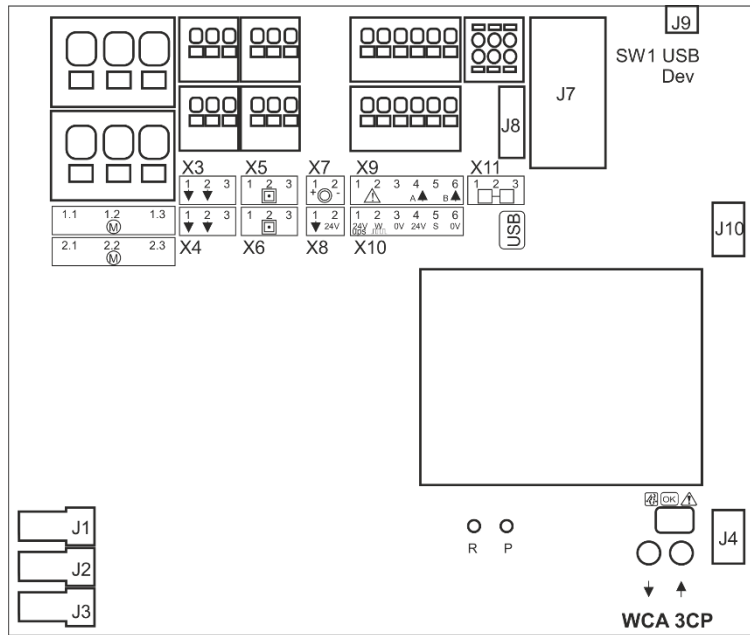

1.1 24V / 0V	} Motorline	X10	10.1 24V UPS	} Weather station with wind direction
1.2 Cable monitoring / MotorLink®			10.2 Wind speed	
1.3 0V / 24V			10.3 GND / 0V	
2.1 24V / 0V	} Motorline	10.4 24V	} WSK-Link™ Slave	
2.2 Cable monitoring / MotorLink®		10.5 Rain		
2.3 0V / 24V		10.6 GND / 0V		
3.1 Open 1.1	} Comfort key pad #1	X11	11.1 24V IN	} WSK-Link™ Slave
3.2 Close 1.2			11.2 Comm.	
3.3 GND / 0V			11.3 0V IN	
4.1 Open 2.1	} Comfort key pad #2	J1	Power from power supply	
4.2 Close 2.2		J2	Power to motor line card (WCA 3M8)	
4.3 GND / 0V		J3	Connection to AUX	
5.1 24V	} WSK-Link™ Master/Slave	J4	Connection for motor line card (WCA 3M8)	
5.2 Comm.		J7	2 x ethernet	
5.3 0V		J8	USB host	
6.1 24V	} WSK-Link™ Master/Slave	J9	USB device	
6.2 Comm.		J10	Connection for fieldbus card	
6.3 0V		P1	Control for power supply	
7.1 +	} Only available on WSC 310 / 320	R / P	Reset / Programming	
7.2 -		↓ ↑	Close and open all windows	
8.1 +	} Only available on WSC 310 / 320			
8.2 -				
9.1 Fault	} Output			
9.2 Fault				
9.3 Output A				
9.4 Output A				
9.5 Output B				
9.6 Output B				

**S1
X1 / X2**

The WCA 3CP card has 2 motor lines (X1 and X2) for connection of ±24V standard or MotorLink® actuators.

±24V standard actuators

1.1 24V / 0V	2.1 24V / 0V
1.2	2.2
1.3 0V / 24V	1.3 0V / 24V

MotorLink® actuator

1.1 0V	2.1 0V
1.2 Communication	2.2 Communication
1.3 24V	2.3 24V

The number of actuators per motor line depends on the actuator type, the total power consumption of actuators connected to a motor line can max be 10A and the total max power consumption for both motor lines must not exceed 10A or 20A depending on MotorController type.

Besides actuators, also locking actuators (espagnolettes actuators) type WMB 801/802 and WMB 811/812 can be connected. The power consumption of the locking actuators are not to be included in the 10A / 20A as actuators and locking actuators do not run at the same time.

All actuators on the same motor line will run/be operated simultaneously.

All actuators on the same motor line must be of the same type.

Connection / cable diameter: flexible max 6 mm² / solid max 10 mm².
 Cable length: see the chapter "Cable dimensioning".

Standard ±24V actuators

Examples with 20A power consumption

- a) 20 pcs. WMX 826-1
- b) 10 sets of 2 pcs. WMX 826-2
- c) 4 pcs. WMU 885-1
- d) 2 sets of 2 pcs. WMU 885-2

Connection variant of standard actuators on motor line X1

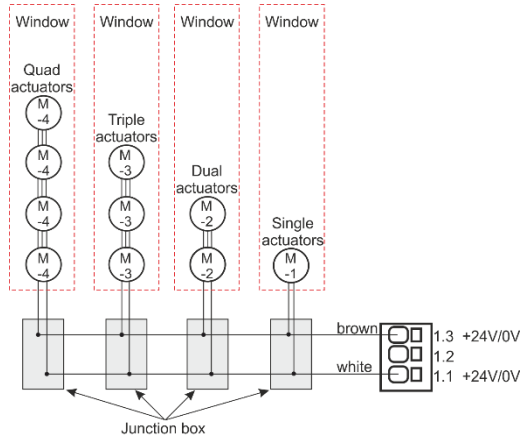

MotorLink® actuators

Examples with actuators per motor line

- Ex. 1: 4 pcs. WMX 823-1
- Ex. 2: 2 pcs. WMX 885-2
- Ex. 3: 3 pcs. WMU 826-3

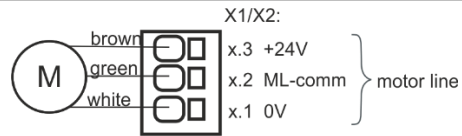

ML-comm = MotorLink™ communication

Allowed actuator combinations on a MotorLink® motor line

The two motor lines on the CP card can each be connected to one of the below shown combinations.

-1 (single): one window with one single window actuator. Up to four windows each with one single window actuator can be connected

-2 (double): one window with two double window actuators.

-3 (triple): one window with three triple window actuators.

-4 (quad): one window with four quad window actuators.

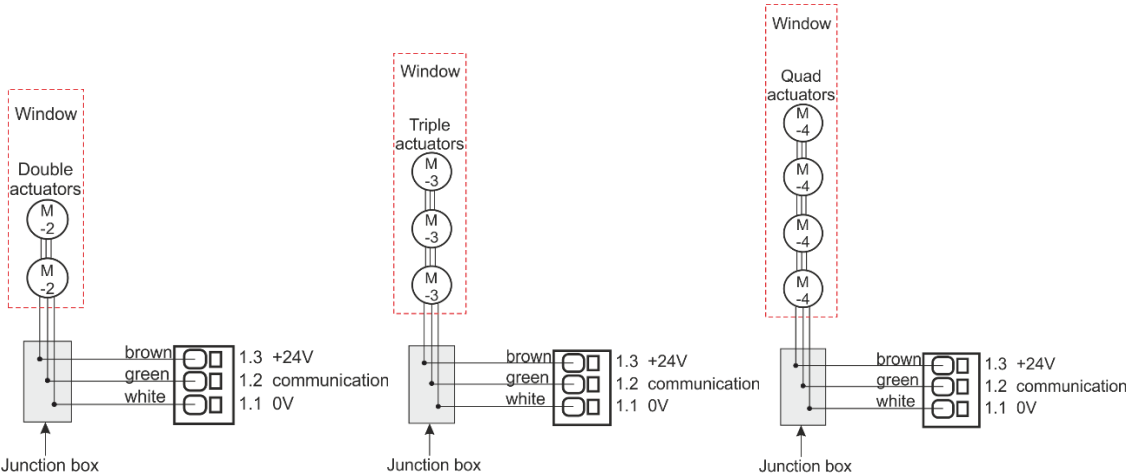
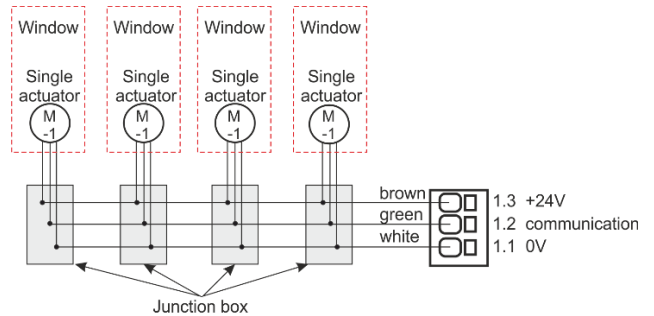

S1
X3 / X4

For connection of comfort keypads.

Data

- | | |
|--------------|--------------|
| 3.1 Open | 4.1 Open |
| 3.2 Close | 4.2 Close |
| 3.3 GND / 0V | 4.3 GND / 0V |

With the default values are input:

"Active" if the contact resistance is smaller than 2kΩ
 "Inactive" if the contact resistance is bigger than 3kΩ.

Input has pull up current of approx. 0.8mA. (min 0.7mA, max 1mA)

Example: comfort keypad connected to input X3

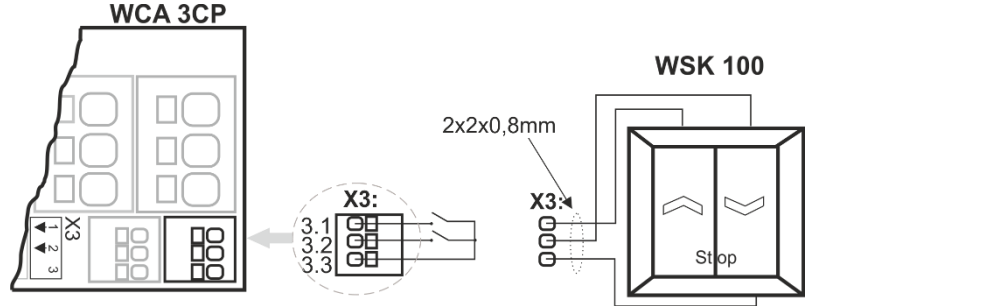

X3 / X4 can also be used as configurable inputs

Input 1

- 3.1 input 1.1
- 3.2 input 1.2
- 3.3 GND 1 / 0V

Input 2

- 4.1 input 2.1
- 4.2 input 2.2
- 4.3 GND 2 / 0V

S1
X5 / X6

Connection of master / slave connection via WSK-Link™.

X5 and X6 are used on the master panel, whereas X11 is used on the slave panel.

Data

- | | |
|-------------------|-------------------|
| 5.1 24V | 6.1 24V |
| 5.2 Communication | 6.2 Communication |
| 5.3 0V | 6.3 0V |

For connection of WSK-Link™ see X11

S1
X9

Solid state outputs, one solid state output for transmission of fault signal and 2 free configurable

Data

- 9.1 Fault – Open contact = Fault, closed contact = OK
- 9.2 Fault – Open contact = Fault, closed contact = OK
- 9.3 Output A
- 9.4 Output A
- 9.5 Output B
- 9.6 Output B

Solid state output for transmission of fault signal.

A fault must last at minimum of 20 seconds before the relay indicate a fault.

Data

- Max voltage: 30 Vp (peak)
- Max output: 150 mA
- Typical On-resistance: 4,7 Ω
- Max On-resistance: 8 Ω
- Max switching speed: 2 ms

2 free configurable solid state outputs

- 9.3 Output A
- 9.4 Output A
- 9.5 Output B
- 9.6 Output B

Data

Max voltage: 30 Vp (peak) AC/DC
 Max current: 150 mA
 Typical On-resistance: 4,7 Ω
 Max On-resistance: 8 Ω
 Max switching speed: 2 ms, only for DC-voltage

Output circuit (simplified)

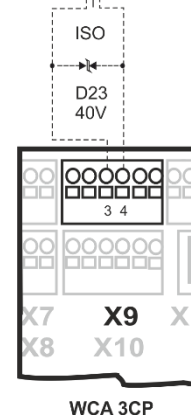

Example with solid state and relay (polarization is not important)

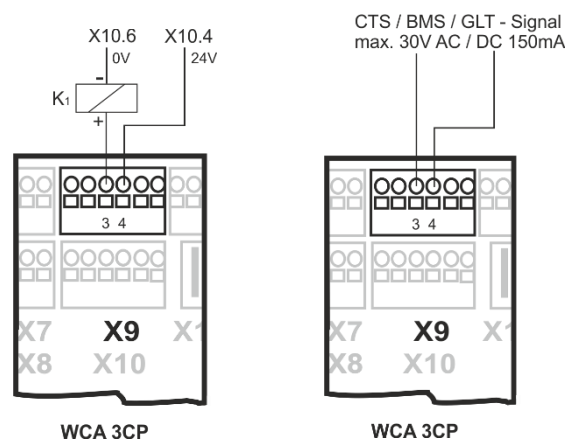

S1
X10

For connection of weather station with wind direction.

Connection of wind / rain sensors type WLA 330 or WLA 340, rain sensor WLA 331.
 Or connection of intelligent weather station (wind direction dependent ventilation), e.g. wind speed sensor WOW 201, wind direction sensor WOW 202, junction box and brackets WOW 203 + 304 and rain sensor WLA 331.

Data

- 10.1 24V AUX
- 10.2 Wind speed
- 10.3 GND / 0V
- 10.4 24V (not active in power saving)
- 10.5 Rain
- 10.6 GND / 0V

With the default values are input:
 "Active" if the contact resistance is smaller than 4kΩ
 "Inactive" if the contact resistance is bigger than 8kΩ.
 For values between 4 and 8kΩ the result will depend on the supply voltage.

Input has pull up current approx. 1mA. (min 0.7mA, max 1.4mA)

Input circuit (simplified)

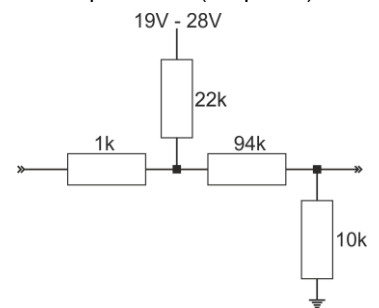

Example 1: Wind/rain and rain sensors

WLA 330 and WLA 331 – the settings of the sensors are set on the sensor.

WLA 340 – the settings of the sensor are programmable on the MotorControlle's touch screen.

Data

- 10.1 24V AUX
- 10.2 Wind speed
- 10.3 GND / 0V
- 10.4 24V
- 10.5 Rain
- 10.6 GND / 0V

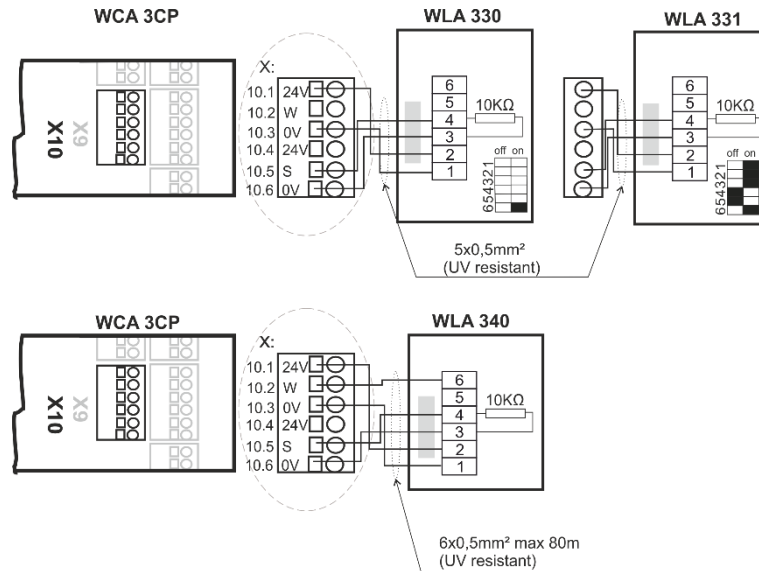

DIP switch 1-3 on WLA 330 must be set for wind speed tolerances. Please refer to the installation instruction for WLA 330 for DIP switch settings.

Example 2: Wind direction dependent ventilation (intelligent weather station)

Data

- 10.1 24V AUX
- 10.2 Wind speed / Direction
- 10.3 GND / 0V
- 10.4 24V
- 10.5 Rain
- 10.6 GND / 0V

As the weather station is monitored by both communication and time out (wind without time), any cable errors will be registered.

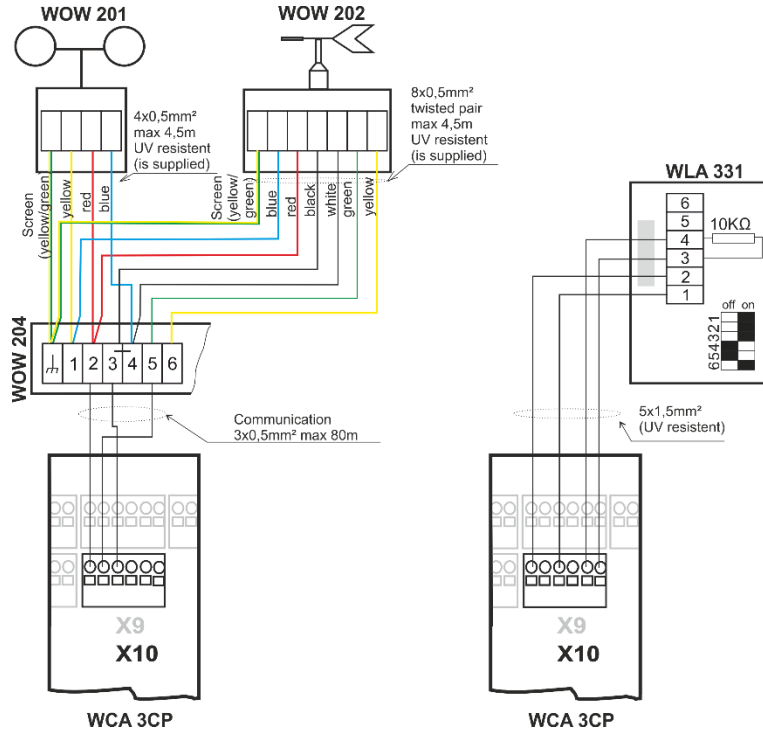

**S1
X11**

For connection of master / slave connection via WSK-Link™.

Data:

- 11.1 24V IN
- 11.2 Communication IN
- 11.3 0V IN

A master-slave connection via WSK-Link™ enables signals to be distributed between several MotorControllers or/and the MotorController may be used as slave in a 230V UPS smoke ventilation system.

On the master MotorController, either use input X5 or X6 for the master-slave connection. On the slave MotorController, the connection is done via X11.

It is possible to connect several MotorControllers in a master slave connection. However, the max total number of MotorControllers on the WSK-Link™ must not exceed 10 units. The max cable length between two units must not exceed 200m, see examples below, for how to connect the MotorControllers.

Sharing of signals from weather station

Example 1

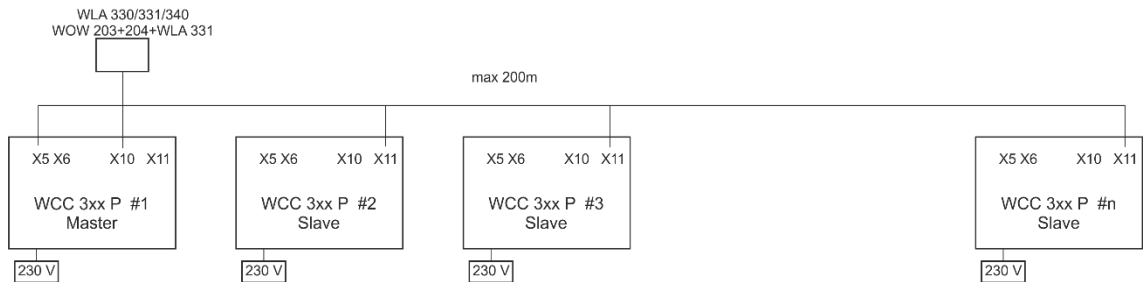

Example 2

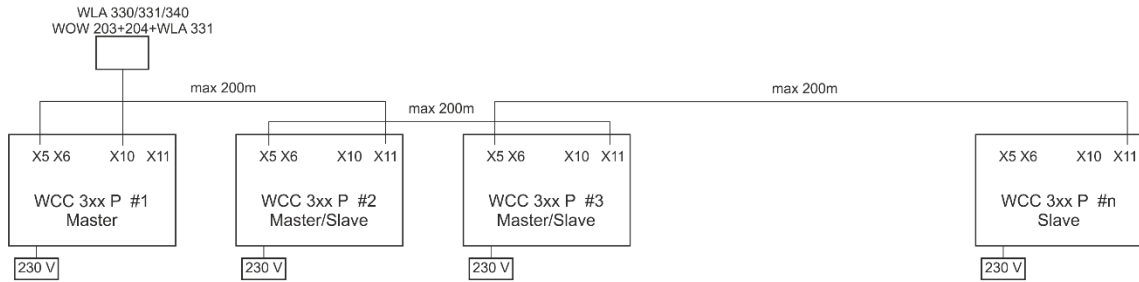

MotorController #2 and #3 are both master and slave MotorControllers.
See under X10 for connection of weather station

WCC 3xx as slave in a 230V UPS supplied smoke ventilation system

Example 1

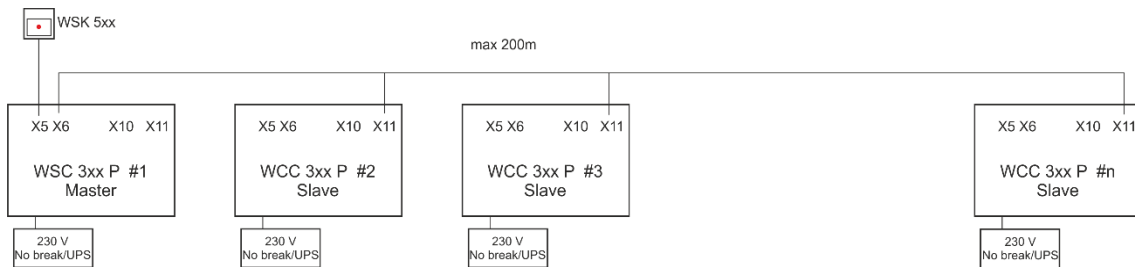

Example 2

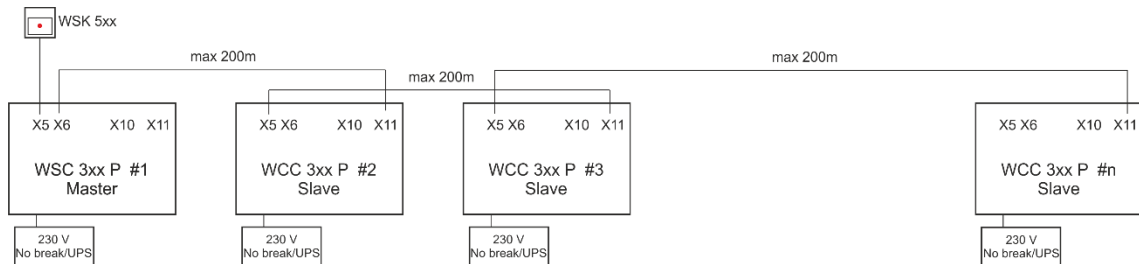

See WSC 3xx instructin for further information about connection to smoke ventilation system.

Even though the connecting method of MotorControllers shown in the #2 example, enables a physical larger system, with longer distances between MotorControllers, WindowMaster recommends connecting the master slave MotorControllers as shown in example #1. As only the master sends e.g. smoke commands and slaves only respond to commands received from the master, the response time in example 2 is heavily increased in comparison with the response time in example 1.

J1	Connection for power supply
J2	Power to motor line card (WCA 3M4 / WCA 3M8)
J3	Connection to AUX (WCA 3P6) – 230V supply
J4	Connection for motor line card (WCA 3M4 / WCA 3M8)
J7	2 x Ethernet connection
J8	USB host. Used to store configurations and to start an event log for e.g. trouble shooting
J9	USB device. Used for remote control and to flash the MotorController.
J10	Connection for fieldbus card
P1	Power supply control
R / P	Reset / programming (used for firmware updates)
LED	Shows the status of the MotorController Yellow = fault, flashing yellow = service timer expired, time for service Green fast flickeing = CPU working, Green constant = CPU communication stopped (possible reset or contact WindowMaster)
↓ ↑	Close / open all windows

10.4 Motor line card – WCA 3M4 / WCA 3M8

The motor line cards WCA 3M4 and WCA 3M8, allows connection of additional 4 and 8 motor lines respectively either $\pm 24V$ standard or MotorLink[®]

The WCA 3M4 / WCA 3M8 is connected to WCA 3CP via a CAN-cable (J3 on WCA 3M4 / WCA 3M8 and J4 on the WCA 3CP).

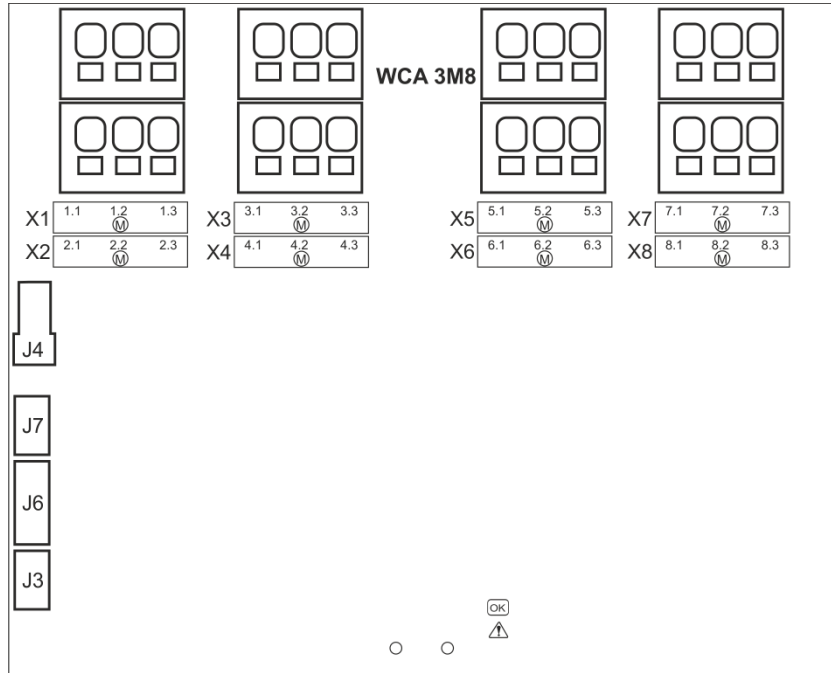

X1	1.1 24V / 0V 1.2 MotorLink 1.3 0V / 24V	} Motorline
X2	2.1 24V / 0V 2.2 MotorLink 2.3 0V / 24V	} Motorline
X3	3.1 24V / 0V 3.2 MotorLink 3.3 0V / 24V	} Motorline
X4	4.1 24V / 0V 4.2 MotorLink 4.3 0V / 24V	} Motorline
X5	5.1 24V / 0V 5.2 MotorLink 5.3 0V / 24V	} Motorline
X6	6.1 24V / 0V 6.2 MotorLink 6.3 0V / 24V	} Motorline

X7	7.1 24V / 0V 7.2 MotorLink 7.3 0V / 24V	} Motorline
-----------	---	-------------

X8	8.1 24V / 0V 8.2 MotorLink 8.3 0V / 24V	} Motorline
-----------	---	-------------

J3 Connection for main control module

J4 Power connection from main control module (WCA 3CP)

J6 Connection to input expansion module (WCA 3KI)

J7 Power supply control

S2	For connection of ± 24 Standard actuators or MotorLink [®] actuators.
X1	<u>Data:</u>
-	x.1 24V / 0V
X8	x.2 ML Communication
	x.3 0V / 24V
	For actuator connections, please see explanation in section "WCA 3CP main control card" under "X1 / X2" and "Max number of actuators per card".
J3	Connection to main control card (WCA 3CP)
J4	Power connection from control card (WCA 3CP)
J6	Connection to input card (WCA 3KI)
J7	Power supply control

10.5 Keypad card – WCA 3KI

The keypad card allows connection of 10 keypads. WCA 3KI requires the WCA 3M4 / WCA 3M8 actuator card.

The WCA 3KI is connected to WCA 3M4 / WCA 3M8 via cable (J1 on the WCA 3KI and J6 on the WCA 3M4 / WCA 3M8).

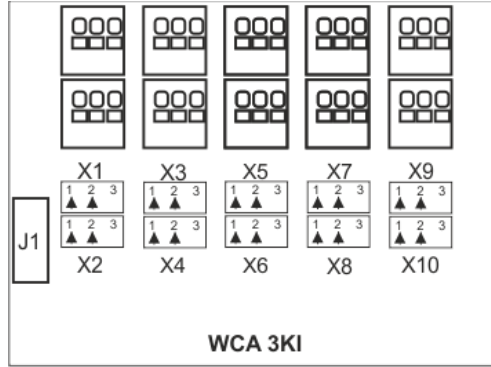

X1	1.1 Open 1.1 1.2 Close 1.2 1.3 GND / 0V	} Comfort keypad #1	X7	7.1 Open 7.1 7.2 Close 7.2 7.3 GND / 0V	} Comfort keypad #7
X2	2.1 Open 2.1 2.2 Close 2.2 2.3 GND / 0V	} Comfort keypad #2	X8	8.1 Open 8.1 8.2 Close 8.2 8.3 GND / 0V	} Comfort keypad #8
X3	3.1 Open 3.1 3.2 Close 3.2 3.3 GND / 0V	} Comfort keypad #3	X9	9.1 Open 9.1 9.2 Close 9.2 9.3 GND / 0V	} Comfort keypad #9
X4	4.1 Open 4.1 4.2 Close 4.2 4.3 GND / 0V	} Comfort keypad #4	X10	10.1 Open 10.1 10.2 Close 10.2 10.3 GND / 0V	} Comfort keypad #10
X5	5.1 Open 5.1 5.2 Close 5.2 5.3 GND / 0V	} Comfort keypad #5			
X6	6.1 Open 6.1 6.2 Close 6.2 6.3 GND / 0V	} Comfort keypad #6	J1	Connection to actuator card (WCA 3M8)	

S3
X1
–
X10

Data:
x.1 Open x.1
x.2 Close x.2
x.3 GND / 0V

↓↑ For input connections, please see explanation in section “WCA 3CP main control card” under “X3 / X4”.

J1 Connection to motor line card (WCA 3M4 and WCA 3M8)

10.6 Power supply card – WCA 3P6

Mains and protective earth is connected to the MotorController via the power supply card.

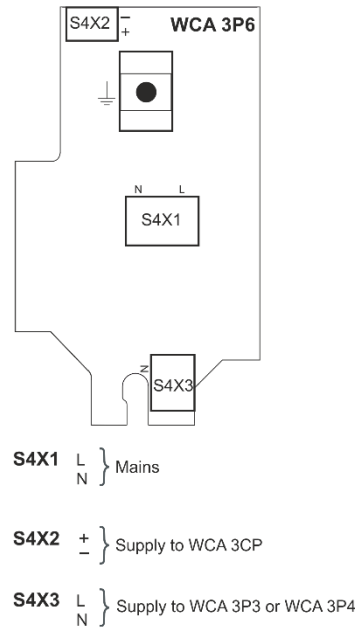

S4 X1	Connection to mains.
S4 X2	AUX connection to WCA 3CP.
S4 X3	Connection to power supply WCA 3P3 (10A) or WCA 3P4 (20A)
	Protective earth (PE).

10.7 Fieldbus cards

Different versions of fieldbus cards are available

- WCA 3FK Fieldbus card with KNX interface
- WCA 3FM Fieldbus card with BACnet MSTP interface
- WCA 3FB Fieldbus card with BACnet IP interface

The connection of a fieldbus card enables communication and access to the available bus-objects depending on the chosen system. There is a set of KNX and BACnet objects available for each motor line and motor group, which provides the options for status and commands.

Status options

E.g. actual position, fault and operation status and the max opening angle (degrees).

Command options

E.g. target position commands with different priority and MotorLink® actuator speed. See "WCA 3FK Application Programming Description.pdf" and BACnet PICS for further information on available KNX and BACnet communication objects.

11 Touch screen

The plus version of the MotorController comes with a touch screen. All connected components (actuators, keypads, weather station etc.) are to be configured on the touch screen.

The menu of the touch screen is in steps:

Step 1: main menu

Step 2: sub menu

Step 3: configuration / showing / operation of the sub menu

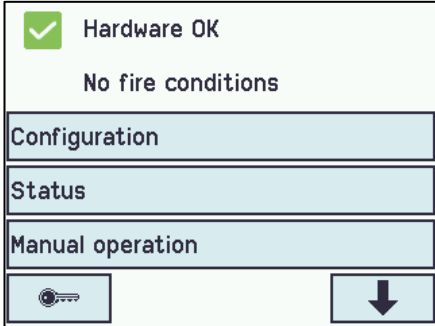

Step 1: Main menu

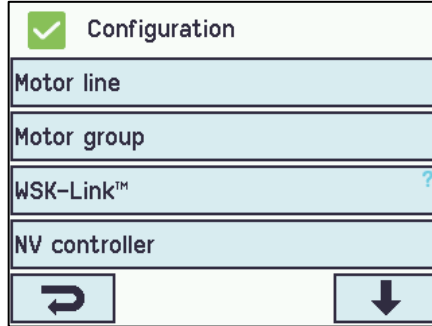

Step 2: Sub menu

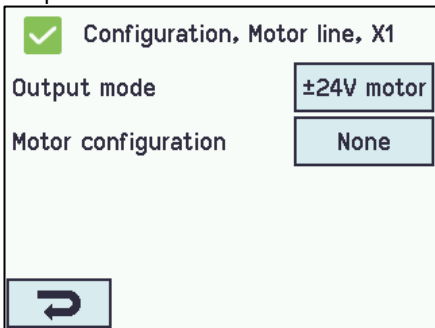

Step 3: Configuring the sub menu

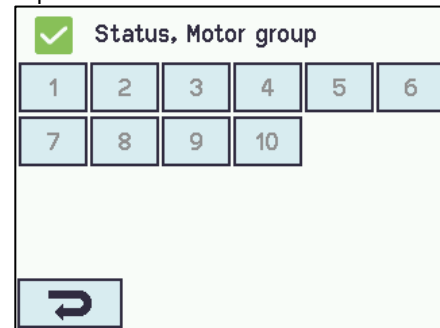

Step 4: Showing the sub menu

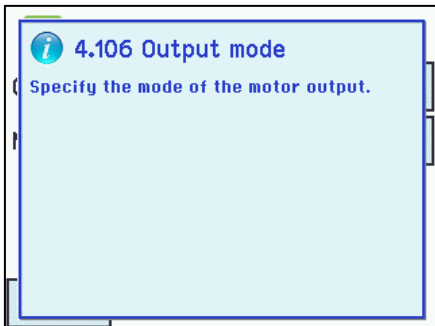

Help text

Help text

The touch screen has a help function with text explaining the menu item.

The help text occurs when the menu item is pressed (text on white background).

For displaying the help text:

→ press the item e.g. "Motor type"

→ the help text appears

→ to turn off the help text press the screen.

11.1 Icons

The MotorController has icons for quick viewing of: fire conditions, hardware OK and hardware error:



Hardware OK: actuators have been configured correctly.



Hardware error: hardware error or connected actuators have not been configured correctly in motor lines or motor groups

11.2 Rotation of the touch screen

The picture on the touch screen can be rotated 180°

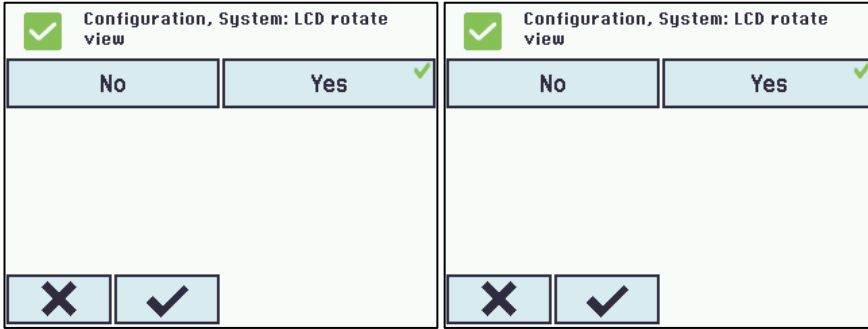

12 Configuration – main menu

All connected components (actuators, keypads, weather station etc.) are to be configured.

As the MotorController has pre-settings for PIN code for access to level 3, the code is to be entered before it is possible to begin the configuration (see chapter 12.10 "Log in").

Before starting on the configuration it can be an advantage to change some of the pre-set settings. Ex. the language can be changed from English to Danish or German (see chapter 12.12 "System") and the orientation of the text on the touch screen can be rotated for a better viewing angle (see chapter 12.12 "System"). It is also possible to change the log out time, which is the time that the access to the access level is open/the touch screen in on (see chapter 12.10 "Log in")

To configure a sub menu:

→ press the light blue number field

→ enter value / the number of the motor line / change factory settings etc. The setting which can be entered depends of the type of the sub menu.

→ accept on

A menu can consist of more screen plays. To get to the next screen: → press

12.1 Motor lines – motor groups

All the components are to be assigned to groups:

- motor lines are to be assigned to motor groups
- keypads are to be assigned to one or more motor groups

12.1.1 Examples with motor lines / motor groups

- 6 motor lines: one or more actuators connected to the lines
- 3 motor groups: the actuators in the motor group are operated simultaneously on the keypad

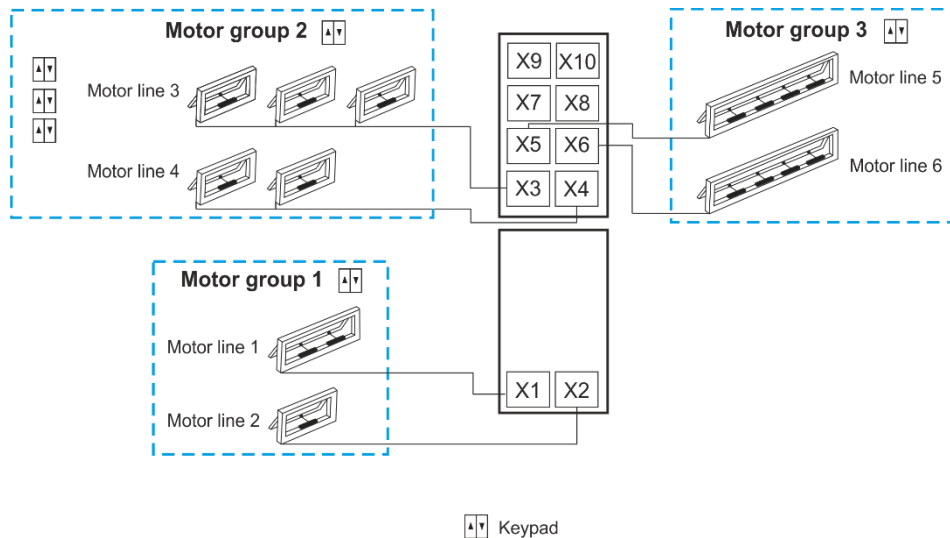

12.2 Motor line

Actuators are to be connected on the motor lines. ±24V standard actuators and actuators with MotorLink® can be connected to all motor lines, but a motor line can only be connected to one type of actuators – either ±24V standard or MotorLink® actuators.

12.2.1 Motor line - numbering

All motor lines are numbered and they are all to be configured.

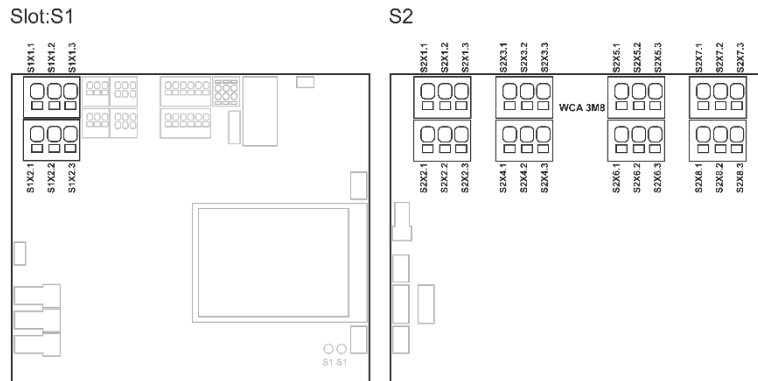

12.2.2 Motor line - configuration

Press "Motor line" and the overview of the motor lines in the MotorController is shown.

Overview configuration motor lines

Configuration, Motor line

All X1 X2

One motor line is marked with a as the configuration is missing.

Configuration, Motor line

All X1 X2

All motor lines are configured.

Both actuators outputs on the main control card as well as the four or eight actuators outputs on the motor line card – if such is connected – are to be configured:

- Motor lines with actuators connected are to be configured in "motor group"
- Motor lines with no actuator connected are set to "none"

Since ±24V actuators and actuators with MotorLink® are not to be configured exactly the same way, both type of actuators are listed below with the settings that are to be configured for each actuator type. Be aware that both types of actuators can be connected to the MotorController at the same time.

For ±24V actuators the full chain length is define as a runtime of 60 seconds. When the MotorController is to be 100% sure that the windows ae 100% open or closed, the chain length is run twice (120). This can have an influence when configuring the a sequence control.

Motor lines configuration

Configuration, Motor line, X1

Output mode ±24V motor

Motor configuration No cable monitoring

Stroke time 60 s

Motor group -

±24V actuator configuration

The ±24V actuators can be configured in:

1. Output mode: informs the type of the actuator selected
2. Motor configuration
3. Stroke time
4. Motor group

The appendix contains all the menus that can be configured - see appendix for detailed explanation.

The MotorLink® actuators are to be configured in:

<div style="border: 1px solid black; padding: 5px;"> <div style="display: flex; align-items: center; margin-bottom: 5px;"> ✔ Configuration, Motor line, X1 </div> <div style="display: flex; justify-content: space-between; margin-bottom: 5px;"> Output mode <div style="border: 1px solid black; padding: 2px 5px;">MotorLink™</div> </div> <div style="display: flex; justify-content: space-between; margin-bottom: 5px;"> Expected no. of motors <div style="border: 1px solid black; padding: 2px 5px;">1</div> </div> <div style="display: flex; justify-content: space-between; margin-bottom: 5px;"> Motor group <div style="border: 1px solid black; padding: 2px 5px;">-</div> </div> <div style="display: flex; justify-content: space-between; margin-bottom: 5px;"> Expected no. of locking motors <div style="border: 1px solid black; padding: 2px 5px;">None</div> </div> <div style="display: flex; justify-content: space-between; margin-top: 5px;"> <div style="border: 1px solid black; padding: 2px 5px; text-align: center;">↶</div> <div style="border: 1px solid black; padding: 2px 5px; text-align: center;">↓</div> </div> </div> <p style="text-align: center; margin-top: 5px;">MotorLink® motor configuration</p>	<ol style="list-style-type: none"> 1. Output mode: informs the type of the actuator selected 2. Expected no. of motors (<i>displayed if actuator type = MotorLink®</i>) 3. Motor group 4. Expected no. of locking motors <ol style="list-style-type: none"> 4.1 No. of found locking motors (<i>see appendix</i>) <p>The appendix contains all the menus that can be configured - see appendix for detailed explanation.</p>
--	--

12.2.3 Colour code - motor line

The overview fields on the touchscreen have colour codes for the motor lines:

Colour	Meaning
Yellow triangle icon	Fault in the configuration or actuator
Strikethrough grey	No configuration of the motor line / the motor line doesn't exist
Black text	The motor line are configured, the actuator has not been closed
Green	The motor line has been configured; the actuator has been closed MotorLink® motor lines will be marked in green, if the actuator / actuators on the motor line has been closed 100% and the point zero of the actuator has been determined.
Light grey number	The motor line are configured with 'No actuator are connected'
Blue ?	Configuration is missing

12.3 Motor group

Motorlines can be assigned to motor groups. See the example "Example of motor lines / motor groups" in the beginning of this chapter for further details.

12.3.1 Motor group - configuration

Press "Motor group" and the overview of the motor groups in the MotorController is shown.

Motor group configuration

<div style="border: 1px solid black; padding: 5px;"> <div style="display: flex; align-items: center; margin-bottom: 5px;"> ✔ Configuration, Motor group </div> <div style="display: flex; justify-content: space-between; margin-bottom: 5px;"> <div style="display: flex; gap: 5px;"> <div style="border: 1px solid black; padding: 2px 5px;">1</div> <div style="border: 1px solid black; padding: 2px 5px;">2</div> <div style="border: 1px solid black; padding: 2px 5px;">3</div> <div style="border: 1px solid black; padding: 2px 5px;">4</div> <div style="border: 1px solid black; padding: 2px 5px;">5</div> <div style="border: 1px solid black; padding: 2px 5px;">6</div> </div> <div style="display: flex; gap: 5px; margin-top: 5px;"> <div style="border: 1px solid black; padding: 2px 5px;">7</div> <div style="border: 1px solid black; padding: 2px 5px;">8</div> <div style="border: 1px solid black; padding: 2px 5px;">9</div> <div style="border: 1px solid black; padding: 2px 5px;">10</div> </div> </div> <div style="margin-top: 10px; text-align: center;"> <div style="border: 1px solid black; padding: 2px 5px; width: 30px; margin: 0 auto;">↶</div> </div> </div> <p style="text-align: center; margin-top: 5px;">Motor group overview</p>	<p>Motor groups are to be configured in:</p> <ol style="list-style-type: none"> 1. Comfort open position 2. Comfort open close time 3. Wind directions where to close during alarm <p>The appendix contains all the items that can be configured - see appendix for detailed explanation.</p>
--	---

12.3.2 Colour code – motor group

The overview fields on the touch screen have colour codes for the motor groups:

Colour	Meaning
Yellow triangle icon	One or more of the assigned motor lines has a failure
Black text	The motor group is configured
Green field	All the assigned motor lines are closed
Light grey number	The motor group is configured but no motor lines are assigned
Blue ?	Configuration is missing

12.4 Local input

The MotorController has two programmable inputs and one input for wind/rain. If further inputs are needed, the input card WCA 8KI (requires the motor line card) can be added. This card has ten local inputs.

The touch screen has an overview of the local inputs.

12.4.1 Numbering of local inputs

All local inputs are numbered.

The number of the input depends on its location on a card - see overview below.

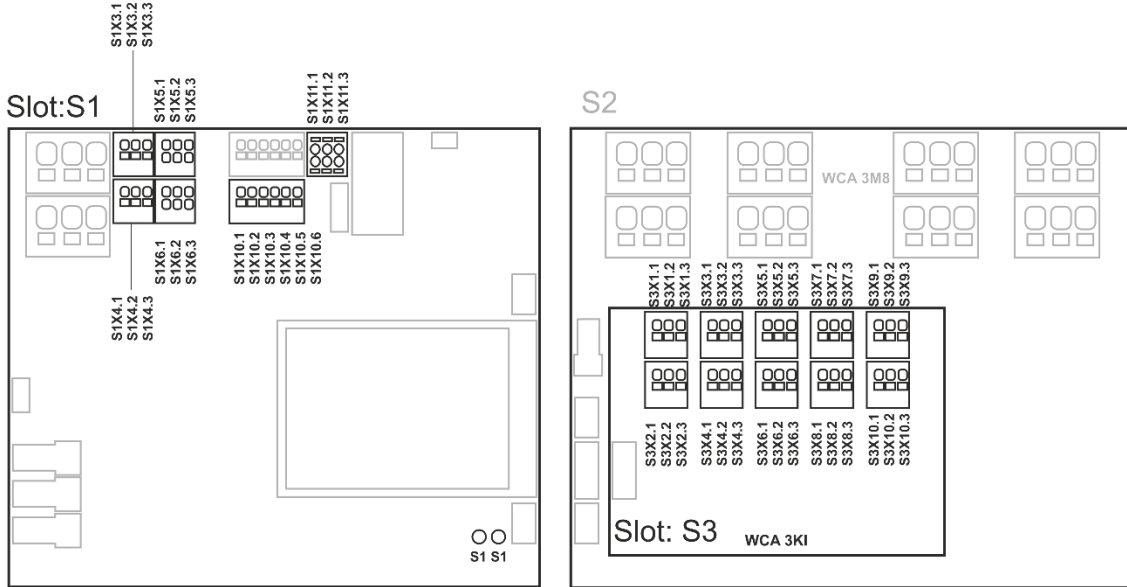

MotorController with input card

12.4.2 Local input - configuration

If component are installed in one or more inputs, these inputs are to be configured.

Which item to be configured depends on the type of input – see description below.

Local input - configuration																									
<div style="border: 1px solid black; padding: 5px;"> <p><input checked="" type="checkbox"/> Configuration, Local input</p> <table border="1" style="width: 100%; text-align: center;"> <tr> <td>-</td> <td>S1X7.x Smoke</td> <td>S1X10.x Safety</td> <td>S1 X3.1</td> <td>S1 X3.2</td> <td>S1 X4.1</td> </tr> <tr> <td>S1 X4.2</td> <td>S1 X8.x</td> <td>S1 Close</td> <td>S1 Open</td> <td>S3 X1.1</td> <td>S3 X1.2</td> </tr> <tr> <td>S3 X2.1</td> <td>S3 X2.2</td> <td>S3 X3.1</td> <td>S3 X3.2</td> <td>S3 X4.1</td> <td>S3 X4.2</td> </tr> <tr> <td>S3 X5.1</td> <td>S3 X5.2</td> <td>S3 X6.1</td> <td>S3 X6.2</td> <td>S3 X7.1</td> <td>S3 X7.2</td> </tr> </table> <p style="text-align: center;"> <input type="button" value="↶"/> <input type="button" value="⬇"/> </p> </div> <p style="text-align: center;">Overview 'Local input'</p>	-	S1X7.x Smoke	S1X10.x Safety	S1 X3.1	S1 X3.2	S1 X4.1	S1 X4.2	S1 X8.x	S1 Close	S1 Open	S3 X1.1	S3 X1.2	S3 X2.1	S3 X2.2	S3 X3.1	S3 X3.2	S3 X4.1	S3 X4.2	S3 X5.1	S3 X5.2	S3 X6.1	S3 X6.2	S3 X7.1	S3 X7.2	<p>Example of overview 'Local input' with connected input card (WCA 3KI)</p> <p>“S1 Close” and “S1 Open” are the two buttons on the board.</p>
-	S1X7.x Smoke	S1X10.x Safety	S1 X3.1	S1 X3.2	S1 X4.1																				
S1 X4.2	S1 X8.x	S1 Close	S1 Open	S3 X1.1	S3 X1.2																				
S3 X2.1	S3 X2.2	S3 X3.1	S3 X3.2	S3 X4.1	S3 X4.2																				
S3 X5.1	S3 X5.2	S3 X6.1	S3 X6.2	S3 X7.1	S3 X7.2																				
<div style="border: 1px solid black; padding: 5px;"> <p><input checked="" type="checkbox"/> Configuration, Local input, X3.1</p> <p>Input type Binary</p> <p>Control smoke zones -</p> <p>Control motor groups -</p> <p>Active state On</p> <p style="text-align: center;"> <input type="button" value="↶"/> <input type="button" value="⬇"/> </p> </div> <p style="text-align: center;">Configuration of local input X3 and X4</p>	<p>Input X3 and X4 on WCA 3CP and X1-X10 on WCA 8KI (binary)</p> <p>If local inputs are connected on the card/cards WCA 3CP and/or WCA 8KI, it/they shall be configured in:</p> <ol style="list-style-type: none"> 1. Input type: informs the type of the input “Binary) (not to be configured) 2. Control motor groups <ol style="list-style-type: none"> 2.1 Function in controlled motor groups 2.2 Short output function <p>The appendix contains all the items that can be configured - see appendix for detailed explanation.</p>																								

12.4.3 Usage of wind/rain sensors - WLA 33x

Usage of wind/rain sensors WLA 33x with motor groups (MG):									
<div style="border: 1px solid black; padding: 5px; margin-bottom: 10px;"> <div style="display: flex; justify-content: space-between; align-items: center;"> ✔ Configuration, Local input, Safety X10.5 </div> <table style="width: 100%; border-collapse: collapse;"> <tr> <td style="width: 60%;">Input type</td> <td style="text-align: center;">Binary</td> </tr> <tr> <td>Control motor groups</td> <td style="text-align: center; border: 1px solid black;">1</td> </tr> <tr> <td>Active function in controlled motor groups</td> <td style="text-align: center; border: 1px solid black;">-</td> </tr> <tr> <td>Inactive function in controlled motor groups</td> <td style="text-align: center; border: 1px solid black;">-</td> </tr> </table> <div style="display: flex; justify-content: space-between; margin-top: 10px;"> ↶ ↓ </div> </div>	Input type	Binary	Control motor groups	1	Active function in controlled motor groups	-	Inactive function in controlled motor groups	-	<p>The used input e.g. S1X10.5 is configured to “Control motor groups”, the groups are chosen. Then, in the menu “Active function in controlled motor groups” the function “Safety” is selected. Then, a function for the motor group when inactive can be selected “Inactive function in the controlled motor groups”.</p> <p>By each motor group it is possible to define the max opening for “Safety”, meaning it is possible to allow windows and louvers inside the building to open despite “Safety” (wind/rain).</p> <p>Facade windows, which are allowed to open e.g. 10%, to open despite it rains.</p>
Input type	Binary								
Control motor groups	1								
Active function in controlled motor groups	-								
Inactive function in controlled motor groups	-								
Input shall be configured in:									
<div style="border: 1px solid black; padding: 5px; margin-bottom: 10px;"> <div style="display: flex; justify-content: space-between; align-items: center;"> ✔ Configuration, Local input, S1X10.5 Safety: Active function in controlled </div> <table style="width: 100%; border-collapse: collapse;"> <tr> <td style="text-align: center;">-</td> <td style="text-align: center;">Open</td> </tr> <tr> <td style="text-align: center;">Close</td> <td style="text-align: center;">Stop</td> </tr> <tr style="background-color: #c8e6c9;"> <td style="text-align: center;">Safety</td> <td style="text-align: center;">Comfort open</td> </tr> <tr> <td style="text-align: center;">Comfort step</td> <td style="text-align: center;">Auto. position</td> </tr> </table> <div style="display: flex; justify-content: space-between; margin-top: 10px;"> ✕ ✔ ↓ </div> <p style="text-align: center; margin-top: 5px;">Configuration of local input</p> </div>	-	Open	Close	Stop	Safety	Comfort open	Comfort step	Auto. position	<ol style="list-style-type: none"> 1. In the motor groups configure the input with the function “Safety”. 2. Configure the motor groups when anything else than close (0%) is desired. <p>Note: motor groups also receive “Safety” signals from the smoke zones they are associated with, see below for further information.</p>
-	Open								
Close	Stop								
Safety	Comfort open								
Comfort step	Auto. position								

12.5 Local output

On the WCA 3CP card the MotorController always has one output (X9.1 / X9.2) for fault signal (not configurable output).

12.5.1 Numbering of local output

All local outputs on the WCA 3CP card are numbered.

The number of the output depends on its location on the card - see overview below.

As the output (fault signal) on the WCA 3CP card cannot be configured it is not numbered.

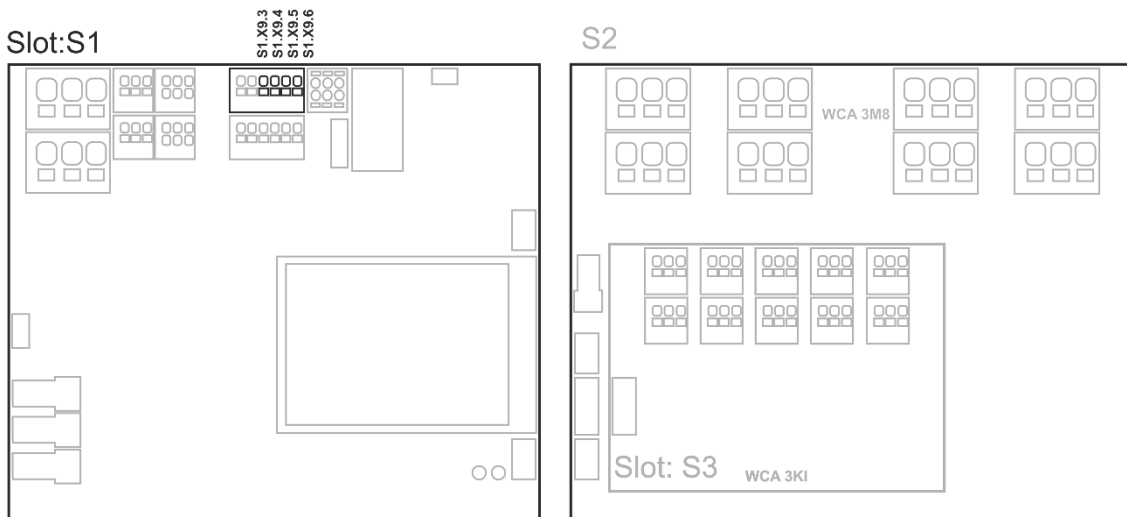

MotorController with motor line and input cards

12.5.2 Local output - configuration

If component are installed in one or more outputs, these outputs are to be configured. Which item to be configured depends on the type of output – see description below.

Local output - overview	
<div style="border: 1px solid black; padding: 5px; margin-bottom: 5px;"> <div style="display: flex; align-items: center;"> <input checked="" style="margin-right: 5px;" type="checkbox"/> Configuration, Local output </div> <div style="display: flex; justify-content: space-around; margin-top: 5px;"> <div style="border: 1px solid black; padding: 2px; font-size: 8px;">A X9.3/4</div> <div style="border: 1px solid black; padding: 2px; font-size: 8px;">B X9.5/6</div> </div> <div style="text-align: right; margin-top: 10px;"> <div style="border: 1px solid black; padding: 2px; width: 30px; float: right;">↩</div> </div> </div> <p style="text-align: center; margin-top: 5px; font-size: 10px;">Overview 'Local output'</p>	<p>Overview 'Local output'</p>
Local output shall be configured in:	
<div style="border: 1px solid black; padding: 5px; margin-bottom: 5px;"> <div style="display: flex; align-items: center;"> <input checked="" style="margin-right: 5px;" type="checkbox"/> Configuration, Local output, A X9.3/4 </div> <div style="margin-top: 5px;"> <p>Output type Binary output</p> <p>Output mode Binary output</p> <p>Controlled by motor groups -</p> </div> <div style="text-align: right; margin-top: 10px;"> <div style="border: 1px solid black; padding: 2px; width: 30px; float: right;">↩</div> </div> </div> <p style="text-align: center; margin-top: 5px; font-size: 10px;">Configuration of a local output (shown for S1 X9.3/4)</p>	<ol style="list-style-type: none"> 1. Output type: informs the type 'Binary output' (is <i>not</i> to be configured) 2. Output mode 3. Controlled by motor groups <ol style="list-style-type: none"> a) Motor group output function b) Logic function c) Status when active d) Time-out <p>The appendix contains all the items that can be configured - see appendix for detailed explanation.</p>

12.6 Weather station type

Here is to be selected which type of weather station –none, WOW or WLA - that is connected.

(The menu "Weather" is only used for input from WCA 3CP input S1X10.2 for wind speed from WLA 340. Input S1X10.2 is also used in combination with weather station WOW 201/202/204 for wind direction dependent smoke ventilation - see chapter 10.3).

WLA 33x is not considered as a weather station and is connected directly to the input X10.5, see chapter 12.4.3.

Weather - configuration	
<div style="border: 1px solid black; padding: 5px; margin-bottom: 5px;"> <div style="display: flex; align-items: center;"> <input checked="" style="margin-right: 5px;" type="checkbox"/> Configuration, Weather </div> <div style="margin-top: 5px;"> <p>Sensor type None</p> <p>WSK Link™ Master present Master not present</p> </div> <div style="text-align: right; margin-top: 10px;"> <div style="border: 1px solid black; padding: 2px; width: 30px; float: right;">↩</div> </div> </div> <p style="text-align: center; margin-top: 5px; font-size: 10px;">Overview 'Sensor type'</p>	<p>Overview 'Sensor type' (selection of type of weather station)</p>

Weather shall be configured in:

Configuration, Weather: Sensor type

None <input checked="" type="checkbox"/>	WOW	WLA 340	From WSK Link™
GMX600	WOW from AOnet	WLA 340 from AOnet	GMX600 from AOnet
WOW from foreign	WLA 340 from	GMX600 from	

Configuration of the sensor

None

(no configuration)

WOW

1. Filter constant
2. Slow filter constant
3. Use RMS in filter

WLA

1. Pulses/sec. per m/s
2. Filter constant
3. Slow filter constant
4. Use RMS in filter

From WSK Link™

(no configuration)

WMX600

1. Filter constant
2. Slow filter constant
3. Use RMS in filter

X from AOnet or foreign

AOnet eller foreign is only used in connection with NV Embedded®, please refer to the NV Embedded® instruction for further details.

The appendix contains all the items that can be configured - see appendix for detailed explanation.

12.7 Sequence control

The sequence control functionality is used where the movement of a motor line must depend on an external event or situation/stage.

To be used where window flaps are overlapping or where the windows cannot open (more than 15%) if the blinds are down a.s.o.

The sequence control can be controlled depending on;

- the position of a different motor line
- the state of a local input
- the state of a KNX object
- the state of a BACnet object

Sequence control configuration

Configuration, Motor line, X1

Sequential control type

Activation of sequence control

The activation of sequence control is to be done for each motor line.

Configuration, Motor line, X1: Sequential control type

None	Open <input checked="" type="checkbox"/>
Close	

Sequence control configuration

The function for the sequence control is to be configured for each motor line

1. **None** - This motor line does not use sequence control
2. **Open** - This motor line must wait for a "result" before opening
3. **Close** - This motor line must wait for a "result" before closing

Sequence control configuration – motor line

Configuration, Motor line, X1

Sequential control position limit

Sequential control with

Sequential control with no

Sequential control position logic

- Sequential control position limit**
the max position the motor line is allowed to have without the „result“ is being fulfilled.
For MotorLink® motor lines stepless variable.
For ±24 Volt motor lines 0 or 100%
- Sequential control with** (*upon what should the motor line wait?*)
 - Motor line.
 - Local input
 - The state of a KNX object
 - The state of a BACnet object
- Sequential control with No**
Upon which number should the motor line wait
- Sequential control position logic**
In which positions should the sequential control be active

12.8 WSK-Link™ - master/slave connection

The WSK-Link™ connection between to MotorControllers is done via input X5 or X6 on the master and input X11 on the slave. A MotorController can have a master/slave connection to several MotorControllers. However, the total max number of connected slaves on the bus must not exceed 10 units.

The total cable length must not exceed 200m, see S1 X11 for examples for connection of MotorControllers.

A slave can only have one master, whereas a master can have several slaves and a MotorController can both be a slave and a master to MotorControllers.

Configuration of Master – Slave system:

Configuration, WSK-Link™

A connected slave MotorController is shown on the master MotorController's touch screen.

When two MotorControllers are connected to each other in a master-slave connection, the slave will appear as a green break glass unit on the master's touch screen.

Configuration, WSK-Link™, no. 1

Device type

Serial number

Associated smoke zone

Use comfort inputs in smoke zone

The slave MotorController's appearance on the master MotorController

On the master's touch screen the Device type of the slave will appear as a WCC 3xx.

12.9 Network

For configuring network addresses.

The WCA 3CP card has a 10/100Mbit Ethernet connection. The connection support DHCP or static IP address as well as Gateway

The appendix contains all the items that can be configured - see appendix for detailed explanation.

Network is used in with BACnet IP interface – contact WindowMaster for further information.

Network shall be configured in:

Configuration, Network

DHCP Yes

Power setting Auto.

↩

Configuration of 'Network'

1. DHCP
2. Power setting

The appendix contains all the items that can be configured - see appendix for detailed explanation.

12.10 Log in

The access level to the MotorController is set in four levels.

Level	Access to	Who has access
1	<u>Public</u> You can see the MotorController from the outside with the door closed and locked	Everyone
2	<u>Operation</u> You can open the MotorController and operate the touch screen for showing the status and manual operating of the windows. All the menus on the touch screen can be viewed but no values can be changed.	Chosen persons with a special key
3	<u>Configuration</u> You can open the MotorController and operate the touch screen for showing status, manual operating of the windows as well as configuration and changing the pre-set values. All the menus and sub menus can be seen and the values can be changed. Access Level 3 can be locked with a PIN code, so there is only access to the level when the PIN is entered	Chosen persons with a special key and having the PIN code for access to level 3. PIN code pre-set to 4321.

? Login level 2

You are logged out. On the touch screen this means, that you are at login level 2.

This level gives access to see status and control user functions such as opening or closing windows.

To change configuration settings, please log in.

The user is on access level 2

The user is at access level 2.

To open for access level 3, enter the PIN for access level 3.

Please enter PIN

PIN code

1	2	3	
4	5	6	<=
7	8	9	0
✕	✓		

Enter PIN code

Enter PIN code.

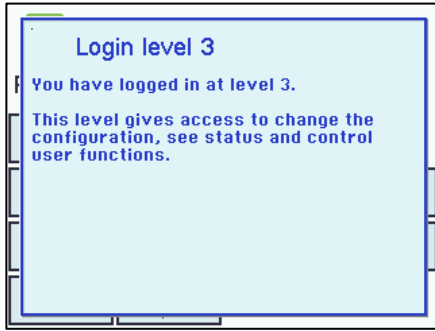

Access approved to login level 3

The user is at access level 3.

Login shall be configured in:

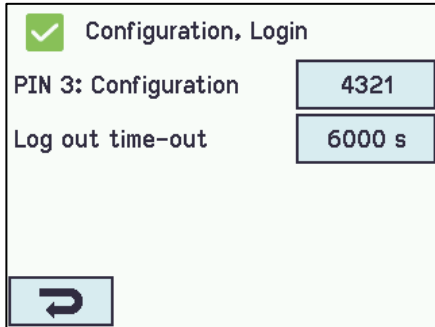



Configuration of login

The access levels can be locked and access to the level is only possible with a PIN code. Each level has a unique PIN code.

1. PIN 3: Configuration
2. Log out time-out (the period of access to the level before the system automatically lock the level)

The appendix contains all the items that can be configured - see appendix for detailed explanation.

It is possible to lock the touch screen before the time has expired: press  followed by pressing 

12.11 Configuration files on USB

The MotorController has a plug in for an USB stick. It is possible to save all the configurations of the MotorController and this way save the stick as documentation. It is also possible to reinstall from the USB stick.

Files on the USB stick can be printed from a computer.

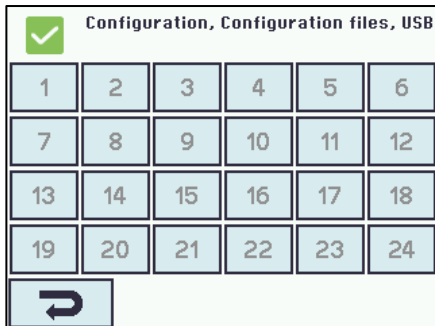

Configuration 'Configuration, files on USB' - overview

Configuration files on USB – overview.

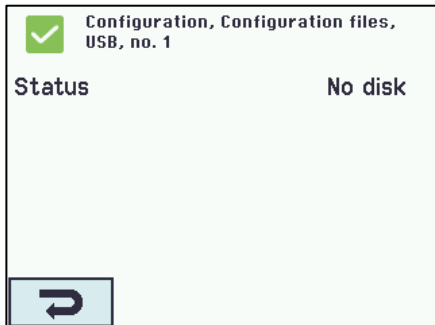

Configuration of 'Configuration files on USB - no.1'.

Configuration of configuration files on USB – shown for no. 1.

12.12 System

It is possible to change settings on the touch screen e.g. language, clock setting, date display, service timer etc.

System can be configured in:	
<p>Configuration of 'System'</p>	<ol style="list-style-type: none"> 1. Language 2. Backup time stamp <i>(not to be configured)</i> 3. Unsaved changes... <i>(not to be configured)</i> 4. Configuration command 5. Time 6. Date 7. LCD rotate view 8. Enable parameter set from network 9. Enable remote control <p>The appendix contains all the items that can be configured - see appendix for detailed explanation.</p>

12.13 Fieldbus (KNX and BACnet)

Only when an Fieldbus card with a fieldbus interface is added to the MotorController will the menus associated with the various fieldbus options be shown.

Fieldbus example	
	<p>An optional card with fieldbus interface is added to the MotorController and the menus (e.g. configuration) now includes KNX and BACnet.</p>

When the Fieldbus card is mounted a set of KNX or BACnet objects are available for each motor line and motor group, which provides the options for status and commands.

Status objects

E.g. actual position, fault and operation status and the max opening angle (degrees).

Command objects

E.g. target position commands with different priority and MotorLink® motor speed.

Fieldbus link - "Conn. 1-10 "

The KNX or BACnet has also 10 configurable binary communication objects.

These can either be used for sending comfort commands to one or more motor groups or to give selected status from smoke zones or motor groups.

See "KNX Application Program Description or "BACnet PICS" on the home pages (www.windowmaster.com) for further information on available KNX or BACnet communication objects.

12.13.1 KNX configuration

KNX bus overview – object configuration	
	<p>Overview of the KNX objects.</p> <p>For each KNX object a direction must be configured</p> <ul style="list-style-type: none"> - None - Input - Output <p>When objects are configured as inputs or outputs, the controlled motor group or smoke zone as well as its function must also be configured.</p>

KNX bus shall be configured in:

Configuration, KNX bus

Module type Konnex

ETS application version 3.00

Physical address 1.1.1

Power setting Auto.



For all the objects the Power setting for the KNX bus must be configured.

12.13.2 BACnet configuration

BACnet overview – object configuration

Configuration, BACnet

Com-mon	Obj. 1	Obj. 2	Obj. 3	Obj. 4	Obj. 5
Obj. 6	Obj. 7	Obj. 8	Obj. 9	Obj. 10	



Overview of the BACnet objects.

For each BACnet object a direction must be configured

- None
- Input
- Output

When objects are configured as inputs or outputs, the controlled motor group or smoke zone as well as its function must also be configured.

BACnet shall be configured in:



Configuration, BACnet

BACnet IP UDP port number 47808

BACnet IP device instance 1

Actual position COV increment 1%

Actual max. position COV increment 1%

For all the objects

1. BACnet IP UDP port number
2. BACnet IP device instance
3. Actual position COV increment
4. Actual max. position COV increment
5. High speed COV increment
6. Wind direction COV increment
7. Register as "foreign device"

13 Status – main menu

In 'Status' you can see the status of all the menu items that can be configured under 'Configuration' as well as e.g. the status of the power supply and slots (inform the type of card in the slot).



Configuration

Motor line

Motor group

WSK-Link™ ?

NV controller

Main overview: status of the system

Under 'Status' is possible to view the status for:

1. Motor line
2. Motor group
3. WSK-Link™
4. NV Controller
5. Local input
6. Local output
7. Power supply
8. CAN (local)
9. Network
10. Slots
11. Configuration files, USB
12. System

It is not possible to configure the items in 'Status' mode. The appendix contains all the items shown in 'Status' - see appendix for detailed explanation.

14 Manual operation and main menu

It is possible to operate the motor lines, the motor groups and the smoke zones direct on the touch screen.

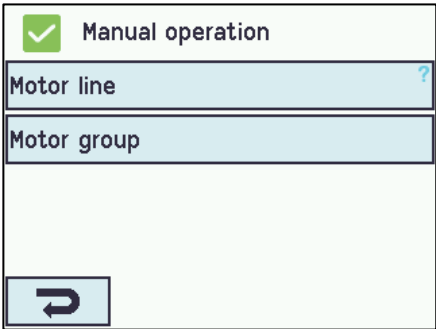
 <p>Main overview: manual operation</p>	<p>What to be manually operated:</p> <ol style="list-style-type: none"> 1. Motor line – see text below 2. Motor group
--	--

Operation types

Motor lines and motor groups

They can be operated **absolutely** (percentage of full open) or **relatively** on the keypad 'open/stop/close' showed on the touch screen.

Example

Manual operation of a motor line

- If 'All' is selected all the actuators are operated simultaneously.
- If a motor line number is selected only the selected motor line is operated.

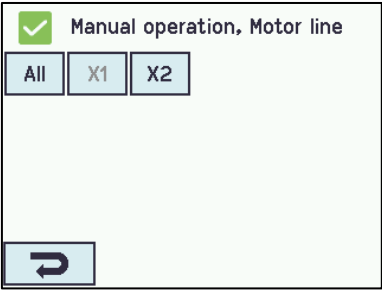
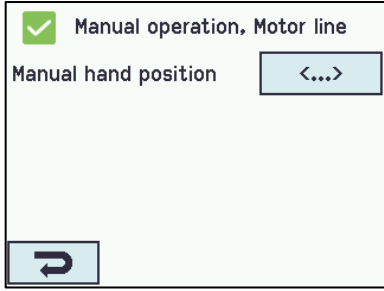
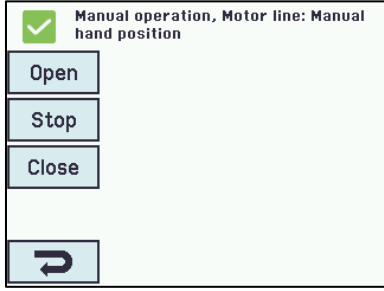
 <p>Motor line – overview</p>	 <p>One motor line is selected</p>	 <p>Manual operation on the touch screen</p>
---	--	--

15 Configuration missing – main menu

If any components, motor lines or motor groups are not configured they are listed here. If you are logged into access level 3 it is also possible to configure from this menu.

16 Hardware error – main menu

If there are any hardware error on the MotorController, they will be displayed here. E.g. if the motor lines are not configured, the main supply is cut of, the type of weather station is not selected etc. If you are logged into access level 3 it is also possible to configure from this menu.

17 View all details – main menu

To make the configuration of the MotorController as simple as possible during configuration, it is only possible to configure the most used functions. Under 'View all details' is displayed all of the above functions together with detailed functions that are not used as often, but are possible to configure. If you are logged into access level 3 it is also possible to configure from this menu.

It is possible to view all details for:

- Motor line
- Motor group
- WSK-Link™
- Local input
- Local output
- Weather
- Power supply
- Network
- KNX-bus
- BACnet
- Slots
- Log in
- Configuration files, USB
- System

18 Remote control of MotorController

It is possible to remote control a MotorController from a PC or via USB device.

When the MotorController is on a standard computer network (Ethernet) you can from any PC with the "WMaFlexiSmokeRemote" program control the MotorController just like if you were standing in front of the itl.

If the MotorController is not connected to a network then it can be remote controlled via a USB connection using the "WMaFlexiSmokeRemote" program.

The program "WMaFlexiSmokeRemote" can be downloaded from our webpages (www.windowmaster.com) under WCC 310 or WCC 320.

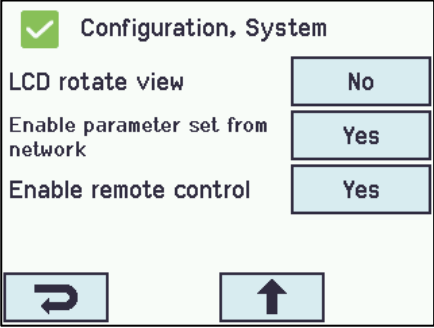
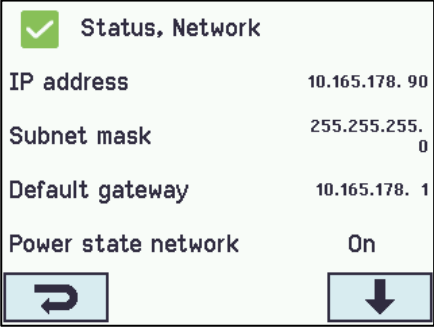
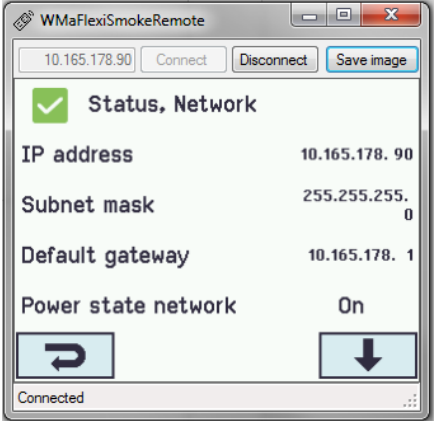
Remote control can be configured in:	
 <p>Configuration of remote control</p>	<p>To enable remote control of the MotorController it is necessary to allow remote control. This is done in the configuration of the system.</p>
 <p>Identification of the IP-address</p>	<p>IP-address of the MotorController</p>
 <p>Screen shot from the PC when controlling the FlexiSmoke™ remotely</p>	<p>Start the 'WMaFlexiSmokeRemote program' on the connected PC. Enter the IP-address and press 'Connect'.</p>

19 Commissioning and test run

In case of hardware error, please see chapter 16 "Hardware error"

We recommend that the software of the MotorController is updated during the annual maintenance check!

19.1 The MotorController is completely installed, without the operating voltage applied

- a) Check all mechanical and electrical components for damage.
- b) Check all screw and plug connections for tightness and/or firm seating
- c) Check that all external components are installed:
 - 1) ±24V actuators: Is the motor end module inserted in the last or only actuator?

19.2 With mains voltage

Adhere to the relevant regulations!

Connect the mains cables and reapply the mains voltage.

19.3 Ventilation keypad

Closely observe the actuators during opening and closing. They must not be impaired in any position by the building structure.

Observe that the actuator cables are not being subject to pulling or pinching.

Check each ventilation keypad individually.

19.4 Wind/rain detector

a) Open the actuators with the comfort ventilation keypads.

b) Wet the rain sensor, the actuators will fully close.

c) While the actuators are running, press the Open button at the keypad. The actuators must neither open nor stop!

Exception: If set to a manual override time (Man. operation after auto comm.).

If the start-up was successful, mount the doors of the MotorController and make back-up.

If the start-up was unsuccessful (error with one of the test run processes), please see chapter 10 "Description of cards".

If necessary, check the wiring in accordance with the cable plan – see chapter 9 "Cable plan for connection to WCC 3xx".

20 Maintenance

Control and maintenance should only be done by the manufacturer or an authorized partner. If the MotorController is a part of a smoke ventilation system control and maintenance must be documented by a mark on the MotorController and in the service book.

Remove all soiling from the MotorController. Check fastening and clamping screws for firm seating.

Carry out a test run of the entire system (see chapter 19 'Commissioning and test run').

Only have defective units repaired in our factory. Only install original spare parts.

We recommend that the software of the MotorController is updated during the annual maintenance check!

The expected minimum lifetime for the MotorController is 10 years.

20.1 Maintenance agreements

WindowMaster offer maintenance agreements for the MotorController. Contact our service department for further information:

telephone +44 1536 510990 or info@windowmaster.co.uk

20.2 Replacement cards

20.2.1 Replacement of 3M4, 3M8 and 3KI cards

1. Disconnect the 230 V.
2. Wait until the display has completely turned off before removing the card.
3. Insert the replacement card.
4. Turn on the 230 V.
5. The system will be ready again after approx. 2 seconds.

20.2.2 Replacement of 3CP card

1. Save a backup of the configuration on a USB stick (recommended).
2. Disconnect the 230 V.
3. Wait until the display has completely turned off before removing the card.
4. Insert the 3PS replacement card.
5. Insert the USB stick into the new card.
6. Turn on the 230 V.
7. Load the parameters from the USB stick
8. The system will be ready again after approx. 2 seconds.

If the WCA 3CP card, which is to be replaced, is completely without function then go straight to point 2.

If there is no backup of the configurations, these are to be entered manually.

It is therefore recommended to take a backup, on a USB stick, when the MotorController is running, if necessary please see chapter 12.11.

21 Declaration of Conformity

The MotorControllers are manufactured and tested accordingly to the European requirements.

The total system is not to be put into service until a declaration of conformity for the total system has been made.

The "Declaration of Conformity" is supplied with MotorController as separate documents.